

# PuduBot 2 Operation Guide

Version: V1.1

Model: PDFD12

Shenzhen Pudu Technology Co., Ltd.



**Copyright © 2022 Shenzhen Pudu Technology Co., Ltd. All rights reserved.**

This document may not be copied, reproduced, transcribed or translated, in part or in whole, by any persons or organizations, or be transmitted in any form or by any means (electronic, photocopy, recording, etc.) for any commercial purposes without the prior written permission of Shenzhen Pudu Technology Co., Ltd. The product specifications and information mentioned herein are for reference only and are subject to change without prior notice. Unless otherwise specified, the manual is intended as a guide only and all the statements are provided without warranty of any kind.

## Introduction

### Purpose

This manual describes the functions, technical specifications, and detailed operations of PuduBot to help users better understand and work with the robot.

### Audiences

This manual is intended for:





- Customers
- Sales engineers
- Installation and commissioning engineers
- Technical engineers

### Revision History

Time	Revision History
2022/07/20	Initial release
2022/08/20	<ul style="list-style-type: none"> <li>• Add description about Recycle Mode</li> <li>• Add description about Automatic self-charging</li> </ul>

### Signs

The signs listed below may appear in this manual with the following meanings.

Sign	Description
 Danger	Indicates high potential hazards, which could cause death or serious personal injury if not avoided.
 Warning	Indicates moderate or low potential hazards, which could cause minor personal injury or robot damage if not avoided.
 Caution	Indicates potential risks, which could cause robot damage, data loss, or unpredictable consequences if neglected.
 Note	Provides additional information as the emphasis and supplement to the main text.

## Table of Contents

1.	Safety Instructions.....	5
1.1	Power Usage.....	5
1.2	Robot Usage.....	5
1.3	Working Environment.....	6
2.	Product Components .....	8
2.1	Overview .....	8
2.2	Appearance & Components .....	8
2.3	Specifications .....	9
3.	How to Use.....	11
3.1	Quick Start Guide.....	11
3.1.1	Power On.....	11
3.1.2	Power Off .....	11
3.1.3	Pause.....	12
3.1.4	Emergency stop .....	12
3.2	Task Scenarios .....	12
3.2.1	Product Features .....	12
3.2.2	Delivery Mode.....	14
3.2.3	Food Delivery Mode.....	20
3.2.4	Cruising Mode .....	24
3.2.5	Direct Mode.....	29
3.2.6	Birthday Mode.....	32
3.2.7	Recycle Modew .....	34
3.3	Settings.....	37
3.3.1	Basic Settings .....	38
3.3.2	Network .....	39
3.3.3	Bluetooth .....	39
3.3.4	Map.....	39
3.3.5	Volume .....	39
3.3.6	Music Library .....	40

3.3.7	Speed .....	40
3.3.8	Charging setting.....	40
3.3.9	Version Updates .....	41
3.3.10	About .....	41
3.3.11	Debugging .....	42
3.3.12	Advanced Settings .....	42
3.4	Tray Adjustment.....	44
3.5	Docking Instructions .....	45
4.	Troubleshooting.....	46
4.1	Troubles during Operation .....	46
4.2	Positioning Failure .....	46
4.3	Charging Failure.....	46
4.4	Power-on Failure.....	47
4.5	Robot Does Not Move Smoothly .....	47
5.	Maintenance and Care .....	48
5.1	Component Maintenance.....	48
5.2	Cleaning Method.....	48
6.	Compliance Information.....	49
6.1	Federal Communications Commission Compliance Statement .....	49
6.2	Industry Canada Compliance Statement .....	49
6.3	Disposal and Recycling Information.....	49

# 1. Safety Instructions

## 1.1 Power Usage

- Do not charge your robot using non-original chargers. If the charger is damaged, replace it immediately.
- When the battery drops to 20%, the robot should be charged timely. Running at a low battery for a long time may impair battery life.
- Make sure that the power voltage matches the voltage indicated on the charger, or it may cause damages to the charger.
- Unplug the charger timely after the charging cycle is complete. Do not leave the charger plugged in for a long time if the robot is fully charged.
- If the robot is not used for a long time, please turn the key switch to OFF.
- Do not expose the battery to high temperatures or heating equipment, including sunshine, heaters, microwave ovens, and water heaters. The battery may explode when overheated.
- Please dispose of the battery according to local regulations and do not dispose of it as household waste. Improper handling may cause the battery to explode.
- Please do not drop the charger or hit it with foreign objects to avoid damage.
- Do not use the battery if it is damaged.
- Designate a person to charge the robot. Do not charge the robot in an unattended manner.

## 1.2 Robot Usage

- Do not cover the robot's top camera while it is working to prevent it from moving abnormally. If the camera is covered, pause the current task and move the robot to the correct route before continuing the task.
- Do not clean or maintain the robot when it is powered on and working.
- Do not put open-flame stoves or any flammable and explosive articles on the robot.
- Do not pick or place dishes while the robot is moving to avoid any food loss or personal injury caused by accidental collision.
- The things shall NOT exceed the size of the tray, otherwise the depth vision sensors may be blocked, and the robot may not move properly.
- To avoid damage to the robot, please ensure that no scattered power cords and sharp objects such as decoration wastes, glass, and nails are on the ground.
- When the robot is in motion, no playing is allowed in front of the robot to avoid unnecessary harm.
- Do not move or transport the robot while it is working to prevent it from moving abnormally.
- In case of emergency, stop the robot by pressing the emergency stop button on the

top.

- The robot must not be disassembled or repaired by untrained personnel. In case of malfunction, contact Shenzhen Pudu Technology Co., Ltd. for technical support in time.
- Observe the maximum weight a person is allowed to lift as required by local laws and regulations when transporting the robot. Keep the robot upright during transportation. Never attempt to transport it by lifting the tray or the box.
- Do not spill any liquid into the robot to avoid any damage.
- Although the robot features automatic obstacle avoidance, never block the robot moving at a high speed to avoid any accidents.
- Please prevent the robot from violent impact or shock to avoid any damage.
- Do not clean the robot with caustic chemicals, cleansers, or detergents. Always clean the robot by wiping it with a clean and dry cloth.
- Please fully charge the battery to 100% before using it, if the robot has not been used for three months, please

### 1.3 Working Environment

- Do not use or charge the robot in a high temperature/pressure environment, areas with fire or explosion hazard, or other dangerous scenarios to avoid personal injury or robot damage.
- The robot can only be used in an indoor environment on a flat and smooth surface with a slope less than  $5^\circ$  and protrusions not more than 1cm high.
- Do not use the robot in a humid environment or on surfaces covered with fluid or gooey stuff to avoid damage to the robot.
- Do not use the robot in places where the use of wireless devices is explicitly prohibited, otherwise it may cause interference to other electronic devices or lead to other dangers.
- The minimum travel width for a single robot is 0.8m. The travel width is recommended to be greater than 2m when two robots pass head-on. Otherwise, they should pass through in turn. The width of the standard entrance should be greater than 1.2 m. Otherwise, it may cause congestion.

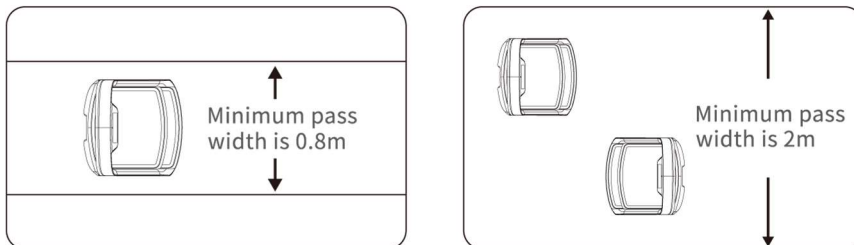

- There is a 35cm space between the two robots placed side by side at the standby point, and a clearance of 15cm from the rear wall and 35cm from the side wall.



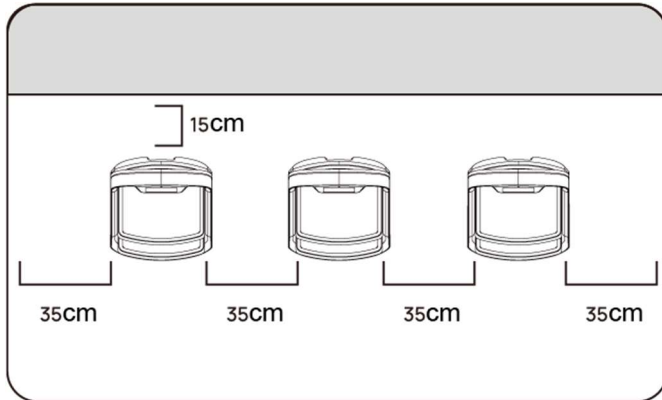

- Things that are black (e.g., skirting line), polished, or transparent (e.g., French window) at the height of 10cm may interfere with the radar reflection and cause abnormal movement of the robot. Such sites should be modified (e.g., posting stickers). Please contact for technical support.
- The maximum climbing angle of the robot is 5°. Do not pause the robot on the slope to avoid any sliding of the robot that may cause loss of things.
- Make sure there's no lighting fixture or other intense light source within the distance of 30cm from the Marker code.
- Do not dispose of the robot or its accessories as household waste. Always dispose of the robot and its accessories according to local laws and regulations, and recycle wherever possible.

## 2. Product Components

### 2.1 Overview

PuduBot 2 is an indoor delivery robot with visual positioning and navigation as well as 3D obstacle avoidance. The robot comes with three removable and adjustable metal trays, suitable for use in restaurants, Internet cafes, hotels and factories. To cater to different business scenarios, PuduBot 2 offers a variety of modes for users to choose from, including food delivery mode, cruise mode, delivery mode, direct mode, birthday mode and collection mode.

### 2.2 Appearance & Components

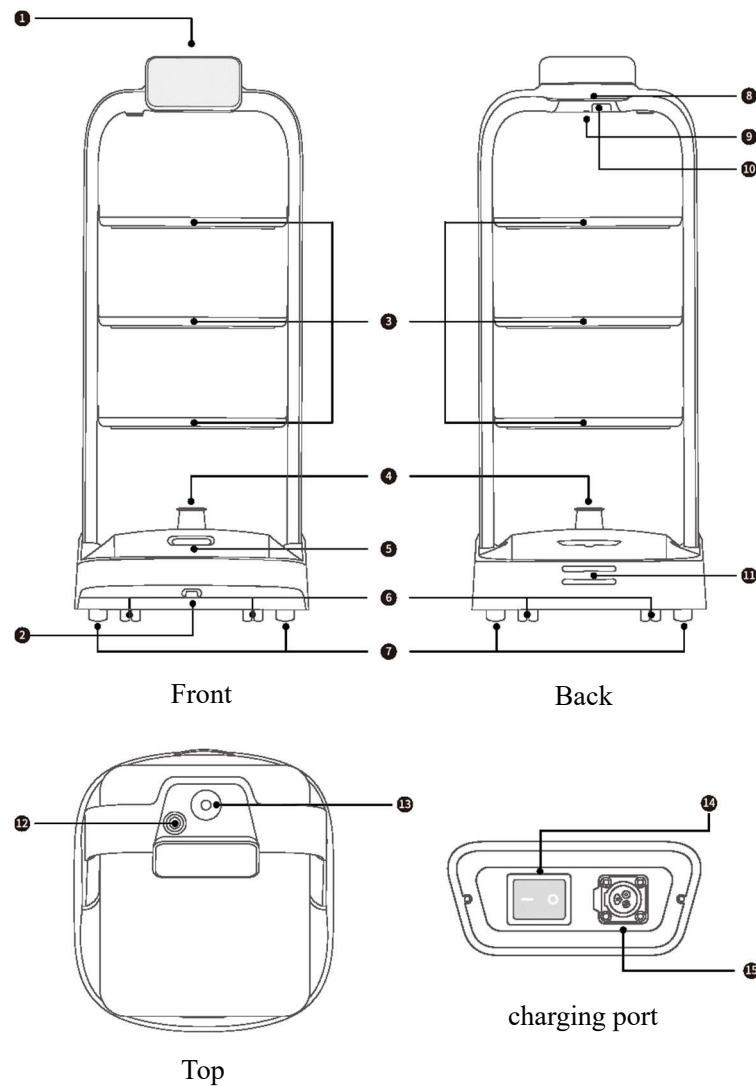

No.	Description
1	LCD screen
2	Secondary LiDAR
3	Trays

4	Primary LiDAR
5	Depth vision sensors
6	Auxiliary wheels
7	Drive wheels
8	Light Strip
9	Power switch
10	Expansion port (1 × Type C)
11	Charging electrode plate
12	Emergency stop switch
13	Upward facing sensor
14	Master switch
15	Charging port

## 2.3 Specifications

Product Feature	Description
Product model	PDFD12
Operating voltage	DC 23 V~29.4 V
Power input	AC 100 V~240 V, 50/60 Hz
Power output	29.4 V, 8 A
Battery capacity	20 Ah
Charging time	About 3h
Battery life	10 h~24 h
Overall weight	37kg
Screen specifications	7" LCD screen
Overall dimensions	580 mm × 535 mm × 1290 mm
Cruise speed	0.5–1.2 m/s (adjustable)
Navigation method	Visual positioning
Minimum passing width	80 cm
Maximum surmountable height	10 mm
Maximum climbing angle	5°

Product Feature	Description
Tray size	520 mm × 435 mm
Number of trays	3
Height between tray levels	Adjustable
Tray supporting capacity	Rated: 10 kg/level; maximum: 13 kg/level
Overall material	PC/aviation grade aluminum alloy
Operating system	Android
Speaker power	10 W ×2 stereo speaker
Working environment	Temperature: 0°C to 40°C; humidity: ≤ 85% RH
Storage environment	Temperature: -40°C to 65°C; humidity: ≤ 85% RH
Operating altitude	< 2000 m
Road surface requirements	Indoor environment with flat, smooth surfaces
IP rating	IP20

## 3. How to Use

### 3.1 Quick Start Guide

#### 3.1.1 Power On

Step 1 Make sure that the master switch has been turned to the "—" position before starting up the robot.

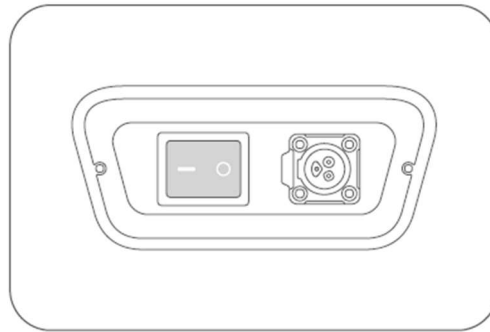

Step 2 Move the robot to the startup location. Press and hold the power switch for 1 second, and the light strip on the top of the robot will turn blue, indicating that the robot has been successfully powered on.

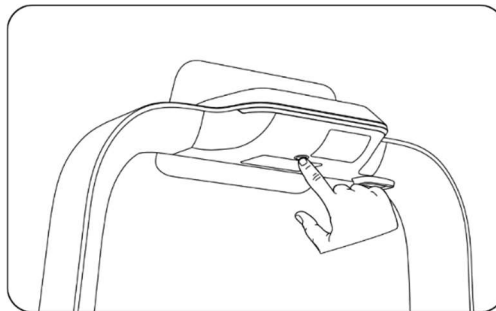

#### Note

The system will automatically start Pudu APP by default after powering on. If not, tap the "Desktop" icon on the system desktop to start it.

Step 3 The robot is powered on, let's try it out!

#### 3.1.2 Power Off

Press and hold the power switch for 3 seconds, and a shutdown prompt will pop up. Click "Confirm" and the light strip on the top of the robot and the screen will turn off, indicating that the robot has been successfully powered off.

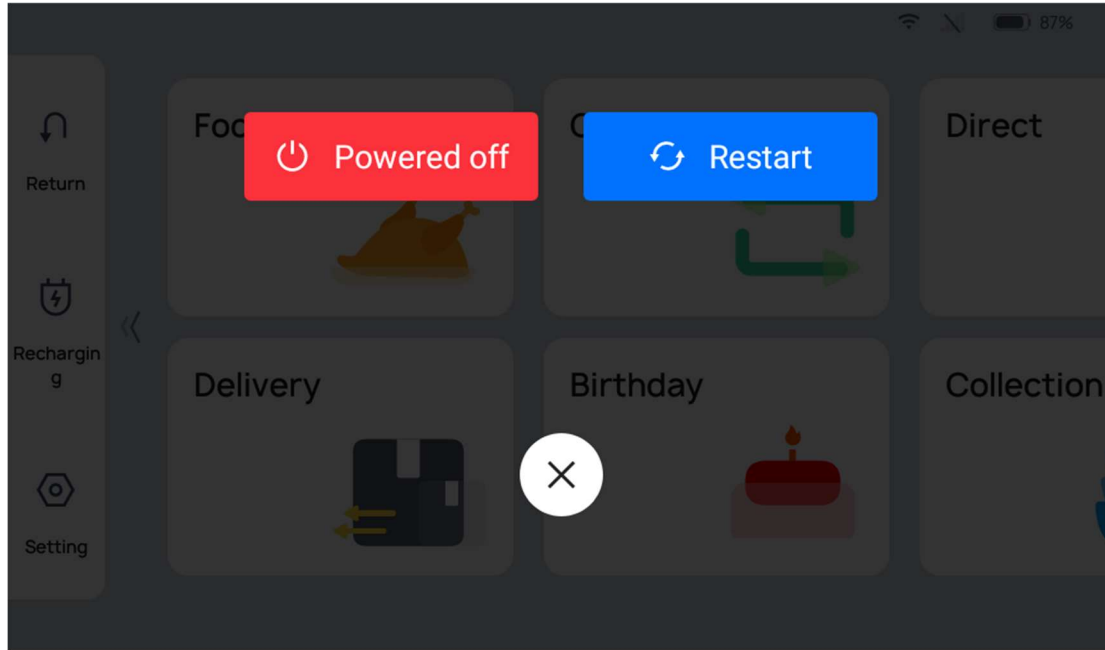

### 3.1.3 Pause

While the robot is moving, the current task can be paused by tapping the screen. Tapping the screen again will resume the current task.

### 3.1.4 Emergency stop

In n case of an emergency while the robot is moving, press the emergency stop switch to stop the robot. Turn the emergency stop switch clockwise and follow the on-screen prompts to resume the robot's operation.

## 3.2 Task Scenarios

### 3.2.1 Product Features

The robot comes with various modes, including Food delivery mode, Delivery mode, Cruise mode, Direct Delivery mode, Birthday mode, and Recycle mode, to cater to the needs of different scenarios. After powering on the robot, you can select the mode as needed in the screen.

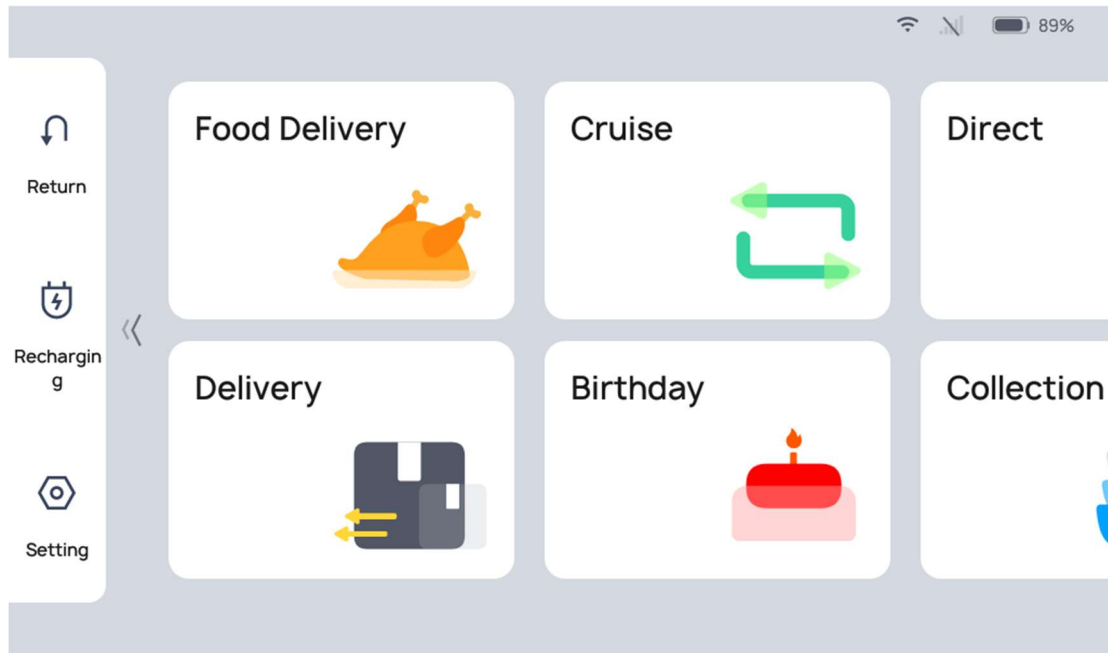

Mode	Description
Food delivery mode	The robot delivers food to multiple tables at the same time. After the dishes ordered by different customers are placed on the trays and the table numbers are entered, the robot automatically plans the best routes for delivery. After that, the robot automatically returns to the standby position.
Delivery mode	The robot delivers things to multiple tables at the same time. After the things ordered by different customers are placed on the trays and the destinations are entered, the robot automatically plans the best routes for delivery. After that, the robot automatically returns to the standby position.
Cruise mode	The robot circulates along a predetermined path with self-service drinks, desserts or napkins, and recommends them to customers by voice.
Direct Delivery mode	You can set a table with a certain number or the dish-washing room as the destination. After performing one-way delivery, the robot exits from the current task instead of returning to the pick-up position.
Birthday mode	The robot delivers birthday cakes or gifts to customers, accompanied by customized background music.
Recycle mode	In Recycle mode, the robot collects the things to be cleaned and delivers them to the collecting point or the dish-washing room.

Note

To ensure a stable and safe operation of the robot, it is recommended that the delivery speed be lower than 0.9m/s, and the cruise speed at 0.5m/s or 0.6m/s.

### 3.2.2 Delivery Mode

In Delivery Mode, an item is delivered to a specified destination, with automatic return to the docking point after completing delivery to the final destination.

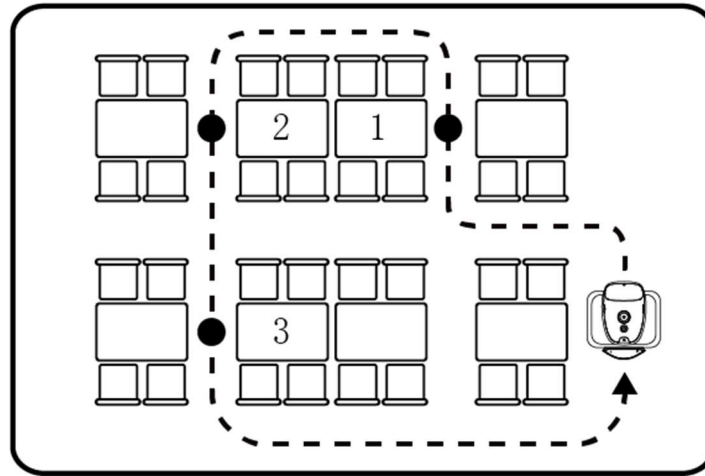

#### 3.2.2.1 How to Use the Main Processes in Delivery Mode

Step 1 On the robot's home page, select “Delivery” to access the main interface for delivery mode.

Step 2 Place the item on the corresponding tray.

Step 3 Tap on the tray bearing the item on the left side of the interface, then select the destination on the right side. The corresponding tray will immediately display the destination name.

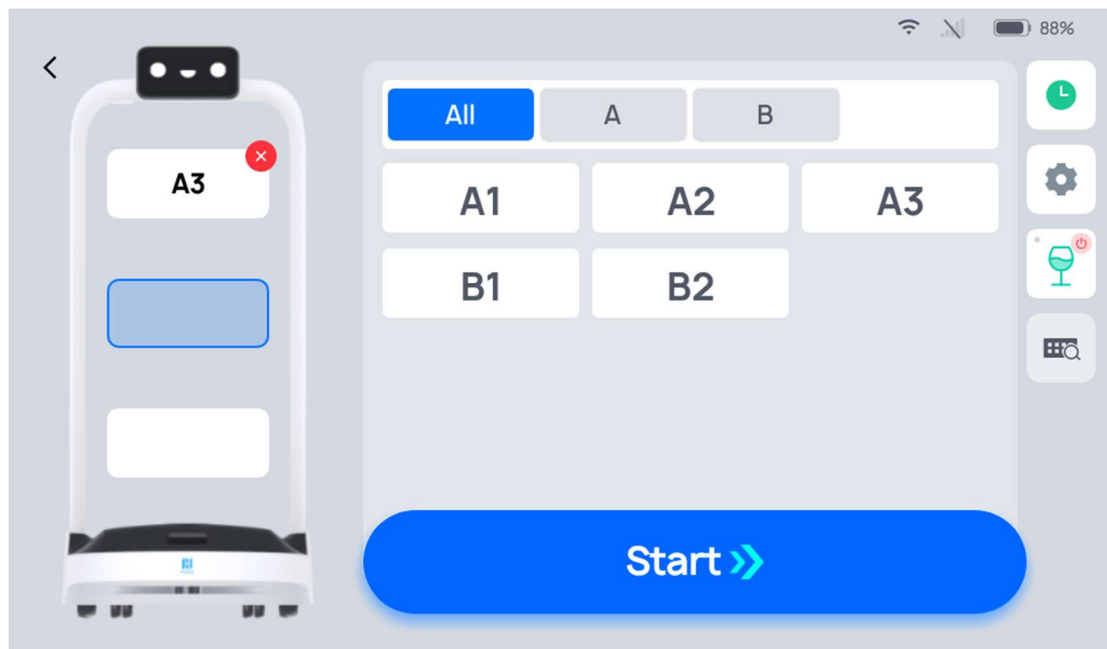

Step 4 Once you have finished entering the destination, tap “Depart.” The robot will proceed to the corresponding destination.

Step 5 Once it reaches its destination, the robot will give a voice prompt. The operator will



remove the item in accordance with the on-screen and voice prompts.

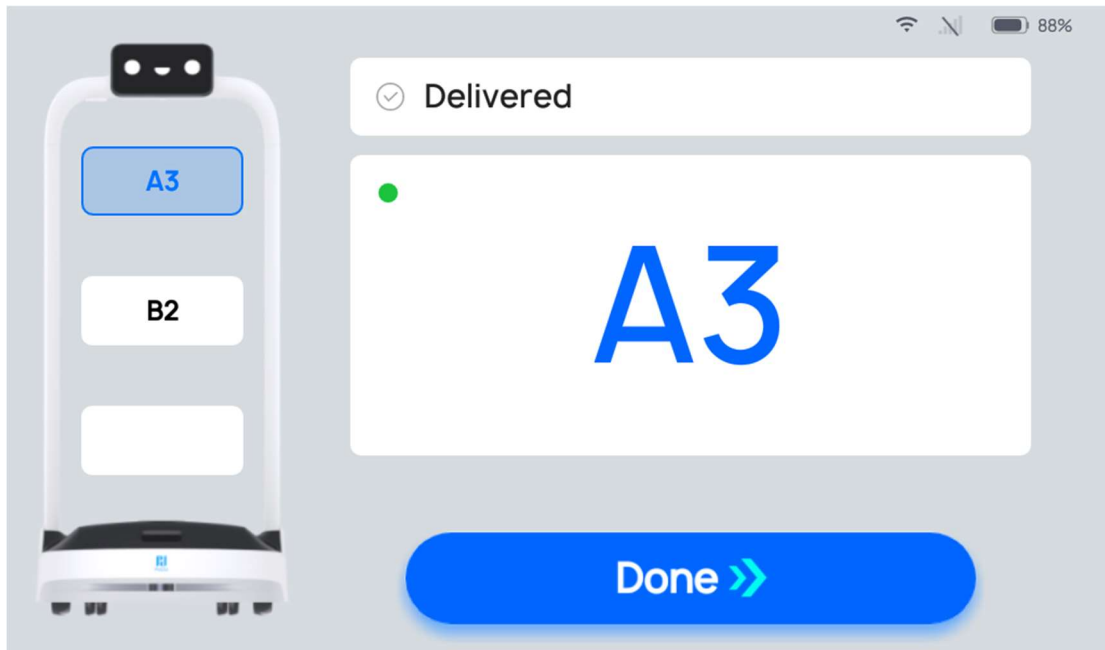

Step 6 Once the operator removes the item, tap “Complete,” and the robot will then begin executing its next task. If the robot has completed all tasks, it will return to the docking point.

During the delivery process, if it is necessary to edit a task, remove a meal in advance, cancel all tasks, or return, you can tap on the robot’s screen to pause the robot before proceeding with the operation. If there are no operations during the countdown period, the robot will continue running.

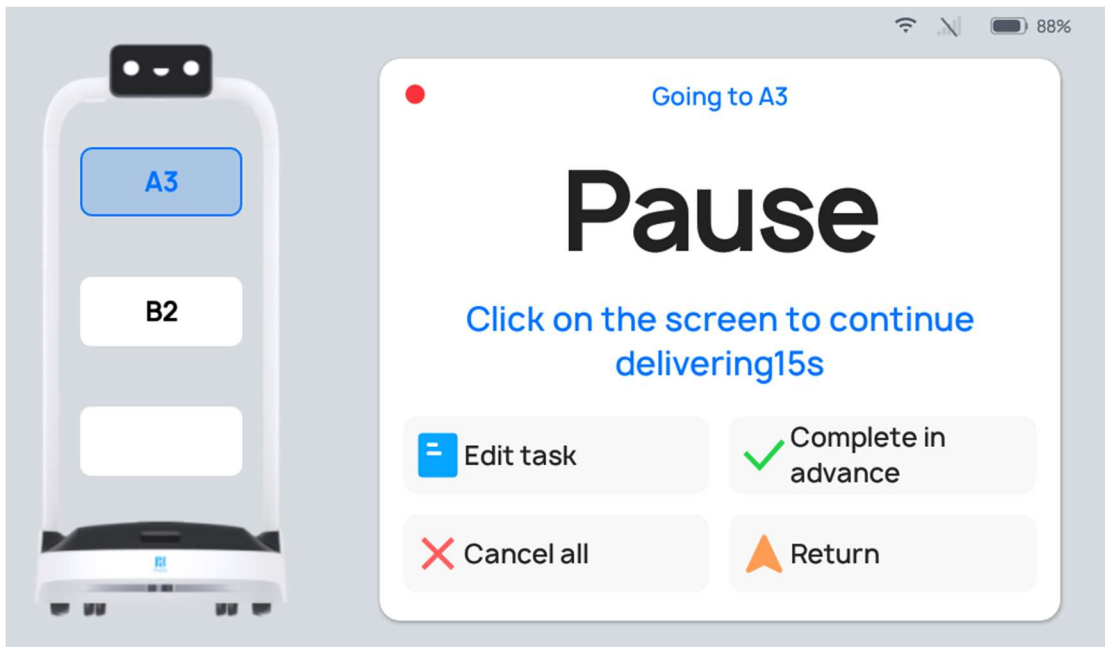

Button	Description
Edit Task	Tap to modify the destination.

Button	Description
Force Complete	Tap to force complete and move on to the next task.
Cancel All	Tap to cancel all delivery tasks and not return to the docking point.
Return	Tap to return to the docking point.

### 3.2.2.2 Description of Delivery Mode Settings

There is a “⚙️” button on the right side of the Delivery Mode interface. Tap it to configure the delivery mode settings. The following settings can be configured:

Settings	Description
Delivery arrival voice message	When this function is enabled, a customized voice message will play on arrival of a delivery. If multiple voice messages are selected, one will play at random for each arrival.
Delivery arrival music	When this function is enabled, the robot will play music on arrival of a delivery.
Music during delivery tasks	When this function is enabled, music will play during delivery.
Delivery to multiple locations with a single tray	When this function is enabled, a single tray can be delivered to multiple corresponding locations.
Traveling Speed	The robot can be configured to travel at a predetermined speed to a destination.
Return Speed	The robot can be configured to travel at a predetermined speed when returning to the docking point.
Task Sequence	The criteria for determining the order of execution of robot delivery tasks can be adjusted.
Selection of Docking Point	Select the default docking point to which the robot will return.

Detailed Description:

#### (1) Delivery Arrival Voice Message

Users can customize the content played for the delivery arrival voice message; after choosing to play content for a customized voice message, the robot will no longer play the default voice message upon arriving at its destination.

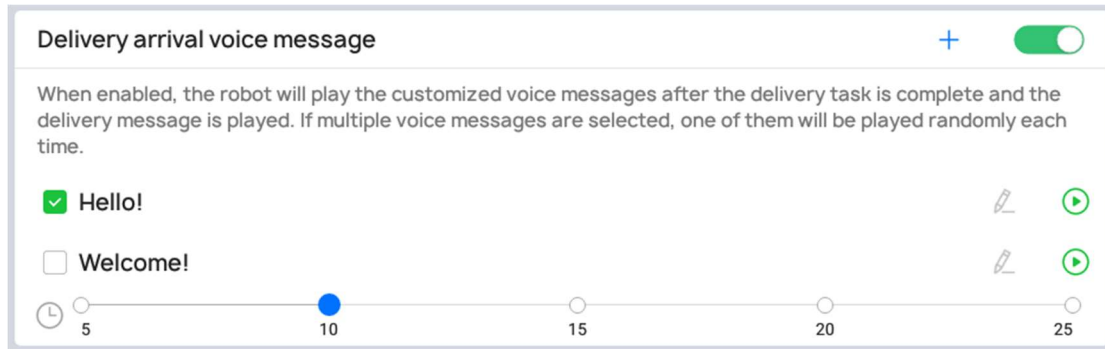

#### Steps for Adding a Customized Voice Message:

**Step 1** Go to “Delivery Arrival Voice Message” in the Delivery Mode “Settings” interface and enable the switch.

**Step 2** In the “Delivery Voice Message” field, enable Cruising Voice Messages and tap on the “+” for the pop-up Voice Message Text Editing window.

**Step 3** In the Voice Message Text Editing window, enter the content you want to be played, and tap “Add/Save” to create a customized voice message. Before creating the voice message, you can tap on the “Test Play” button to test the voice message.

**Step 4** Select the voice message you created, and it will play when a delivery arrives. If multiple voice messages are selected, the robot will randomly select one voice message to play upon arrival.

#### Note:

- Up to 20 voice messages can be added, and up to 100 Chinese characters per voice message are supported.
- Multiple voice messages can be selected, and the robot will randomly select one voice message to play upon arrival of a delivery.
- If you need to delete a customized voice message, long press the corresponding voice message and tap “Delete” .
- The playback interval can be set within the range of 5s-25s; the default is 5s. The playback interval can be manually changed. After making changes, save the settings.

#### (2)Music during delivery tasks

The user can select the music that the robot plays in the process of traveling from the docking point to the destination in delivery mode. Steps for adding music during delivery tasks:

**Step 1** In the home page interface, enter “Settings” - “Music Library,” tap “Import Music” in the top right corner of the interface, and import the music by scanning the code with your phone.

**Step 2** Go to “Music During Delivery Tasks” in the Delivery Mode “Settings” interface and enable the switch.

**Step 3** By checking the box to select music, you can select the music that the robot plays upon arrival. If multiple voice messages are selected, the robot will randomly select one voice message to play upon arrival.

Note:

Added music can be automatically synced with the Delivery Mode music and played once selected:

- Up to 20 music files can be added to the music library, and the added music can be automatically displayed in the “Music Replayed During Delivery Tasks” list.
- Multiple music files can be selected, and the robot will randomly select one music file to play during the delivery process.

Music files cannot be deleted from the list during delivery tasks. If you need to delete a music file, you will need to go to “Settings” - “Music Library” to delete it.

### (3)Delivery Arrival Music

Users can select music to be played by the robot when it arrives at its destination in delivery mode; once the robot arrives at its destination, it will play the voice message, and then play the music. Steps for Adding Delivery Arrival Music:

Step 1 In the home page interface, enter “Settings” - “Music Library,” tap “Import Music” in the top right corner of the interface, and import the music by scanning the code with your phone.

Step 2 Go to “Delivery Arrival Music” in the Delivery Mode “Settings” interface and enable the switch.

Step 3 By checking the box to select music, you can select the music that the robot plays upon arrival. If multiple voice messages are selected, the robot will randomly select one voice message to play upon arrival.

Note:

Added music can be automatically synced with the Delivery Mode music and played once selected:

- Up to 20 music files can be added to the Music Library, and the added music can be automatically displayed in the “Delivery Arrival Music” list.
- Multiple music files can be selected, and the robot will randomly select one music file to play upon arrival of a delivery.
- Music cannot be deleted from the Delivery Arrival Music list; if you need to delete a music file, you will need to go to “Settings” - “Music Library” to delete it.

### (4)Delivering Speed

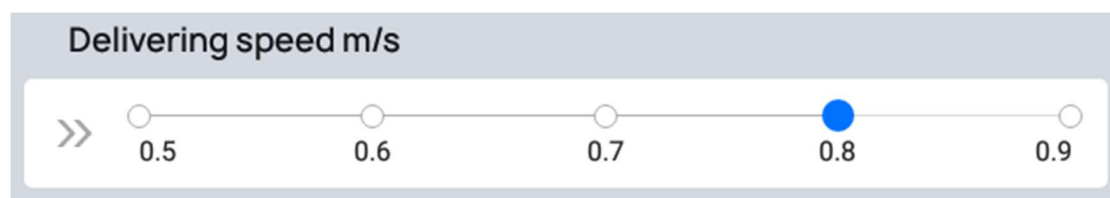

The robot can be configured to travel at a predetermined speed to a destination. The default speed is 0.8m/s, and this can be adjusted by dragging the cursor within the range of 0.5m/s to 0.9m/s.

Note:

If you need to enable higher speeds, you can go to “Settings” - “Advanced” and enable the “High-Gear Traveling Speeds” switch.

(5) Return Speed

The robot can be configured to return to its docking point at a predetermined speed. The default speed is 0.8m/s, and this can be adjusted by dragging the cursor within the range of 0.5m/s to 0.9m/s.

Note:

If you need to enable higher speeds, you can go to “Settings” - “Advanced Settings” and enable the “High-Gear Traveling Speeds” switch.

(6) Task Sequence

You can choose between Prioritized Delivery by Distance and First Come First Served:

- **Prioritized Delivery by Distance:** Before executing a task, the robot will choose the table that is currently at the closest distance and prioritize it in completing delivery.
- **First Come First Served:** Delivery is completed in the order in which tables are entered.

(7) Select docking point

Select the default docking point to which the robot will return.

3.2.2.3 More About Delivery Mode

Settings	Description
Task History	You can view the previous task executed in the current mode
Steady Mode	When this function is enabled, the robot can travel smoothly at a low speed
Default input method	You can modify the destination search method: Direct location selection/smart location search

Detailed Description:



(1) Task History



In the delivery interface, tap the “” button to view the delivery status of the robot’s previous task.

(2) Steady Mode

You can choose whether or not the robot will use steady mode in the process of traveling. In steady mode, the robot will travel at a lower speed, and start and brake more smoothly. The method of use is as follows:

In the “Settings” - “Speed” interface, once the Steady Mode switch is enabled, the symbol “” will be displayed on the Delivery Mode home page:

- Tap the “” icon on the right side of the Delivery interface, and the icon will change to “”, indicating that Steady Mode is enabled.

- Long-press the “” icon on the right side of the Delivery screen for 2s, and the icon will change to “”, indicating that Steady Mode is disabled.

### (3) Default input method

By tapping the “” button on the right side of the Delivery Mode home page, you can modify the input method for selection of a delivery destination in the Delivery interface. There are two input methods:

- **Direct Destination Selection:** The destination list is in a tiled display in the window on the right side of the interface, and you manually and directly find and select the table number.
- **Smart Destination Search:** The robot automatically extracts the first character of all destination names for display, and gradually filters out the destinations by screening the characters as you proceed.

On the “Settings” - “Advanced Settings” page, under “Default Input Method,” you can select the default input method.

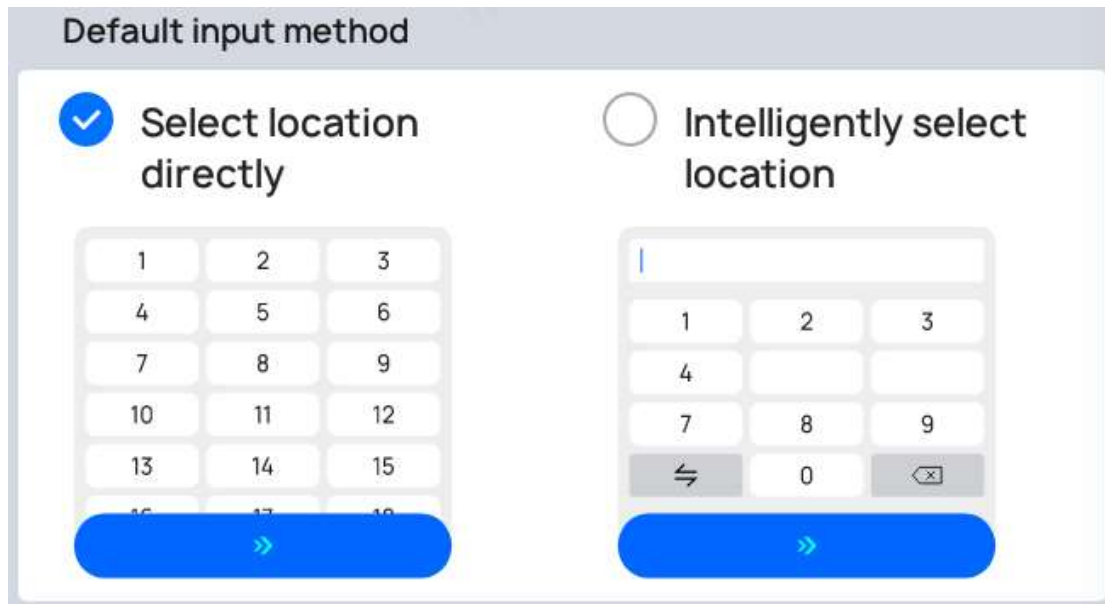

### 3.2.3 Food Delivery Mode

In Food Delivery Mode, food is delivered to a specified destination, with automatic return to the docking point after completing delivery to the final destination.



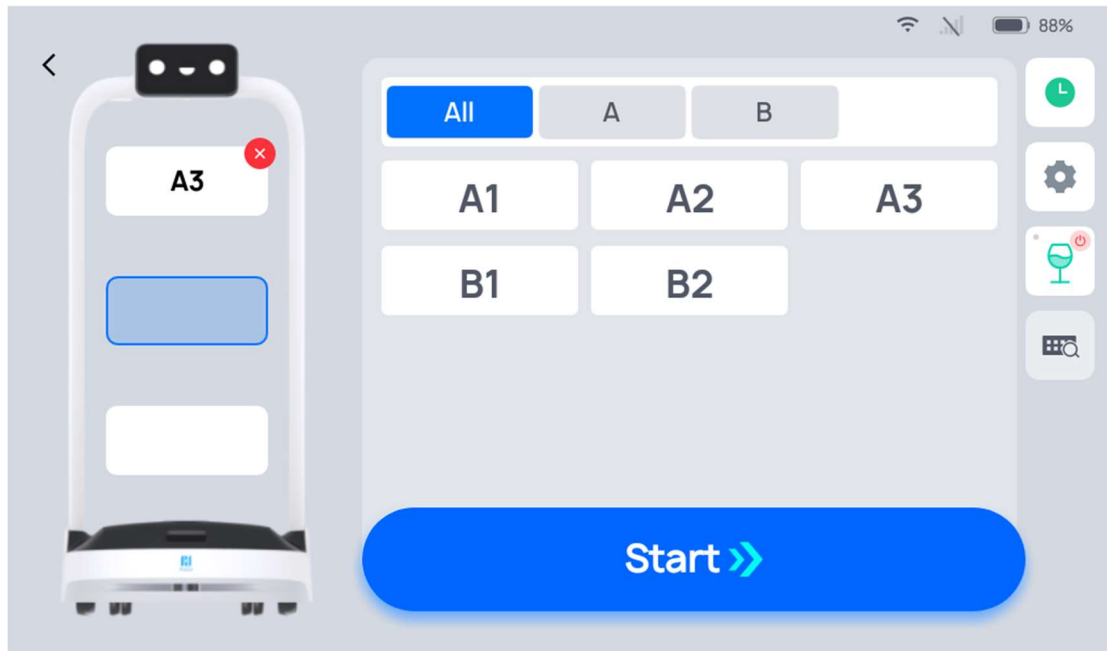

Step 4 Once you have finished entering the destination, tap “Go” The robot will proceed to the corresponding destination.

Step 5 Once it reaches its destination, the robot will give a voice prompt. The server will remove the dishes in accordance with the on-screen and voice prompts.

Step 6 Once the server removes the item, they will tap “Complete,” and the robot will begin executing its next task. If the robot has completed all tasks, it will return to the docking point. .

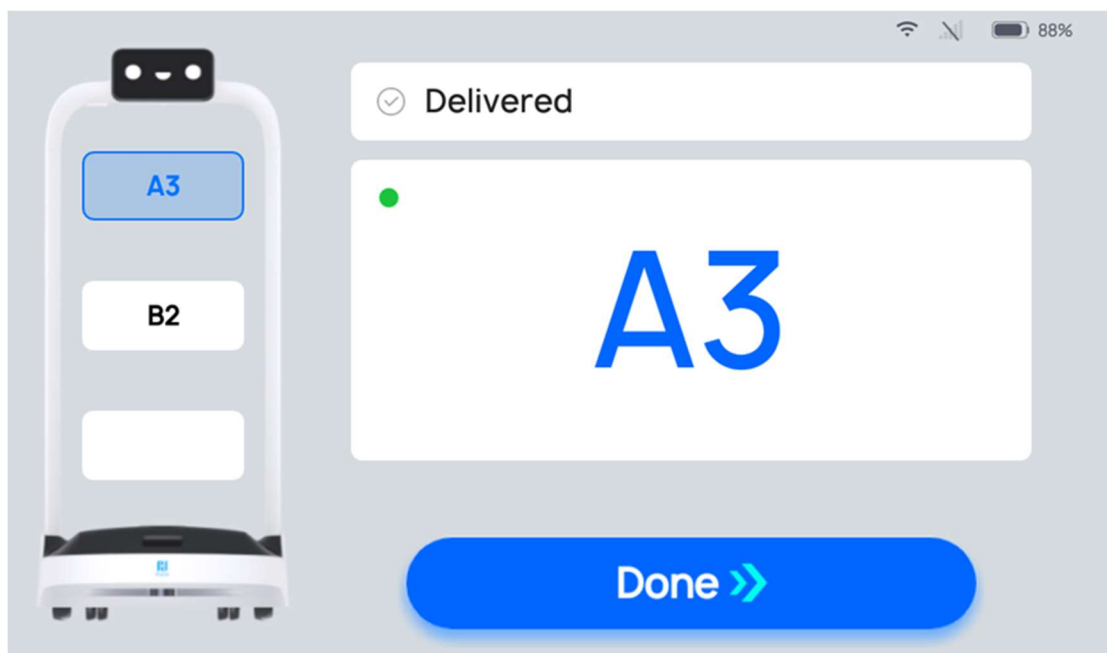

During the food delivery process, if it is necessary to edit a task, force complete, cancel all tasks, or return, you can tap on the robot’s screen to pause the robot before proceeding with the



operation. If there are no operations during the countdown period, the robot will continue running.

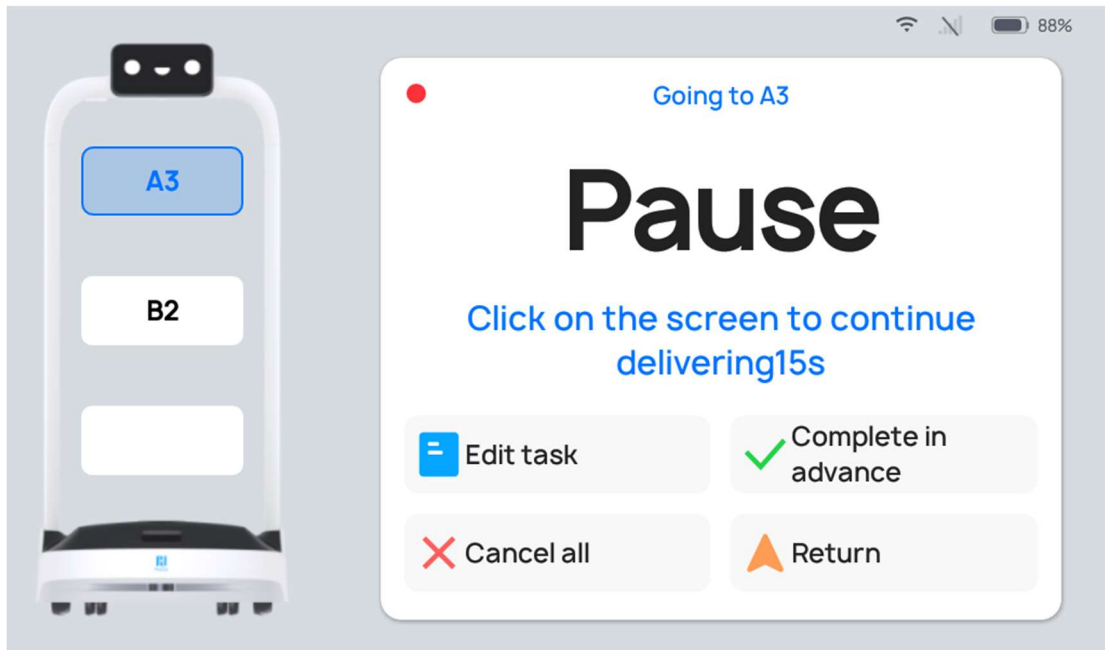

Button	Description
Edit Task	Tap to modify the table number for food delivery.
Force Complete	Tap to force complete and move on to the next task.
Cancel All	Tap to cancel all food delivery tasks and not return to the docking point.
Return	Tap to return to the docking point.

### 3.2.2.2 Description of Food Delivery Mode Settings

There is a “⚙️” button on the right side of the Food Delivery Mode interface. Tap it to configure the delivery mode settings. The following settings can be configured:

Settings	Description
Food Delivery Arrival Voice Message	When this function is enabled, a customized voice message will play on arrival of a delivery. If multiple voice messages are selected, one will play at random for each arrival.
Food Delivery Arrival Music	When this function is enabled, the robot will play music when it arrives on a food delivery task.
Play Music During Food Delivery	When this function is enabled, music will be played while en route for food delivery.
Delivery to multiple locations with a single tray	When this function is enabled, a single tray can be delivered to multiple corresponding locations.

Settings	Description
Traveling Speed	The robot can be configured to travel at a predetermined speed to a destination.
Return Speed	The robot can be configured to travel at a predetermined speed when returning to the docking point.
Task Sequence	The criteria for determining the order of execution of robot food delivery tasks can be adjusted.
Selection of Docking Point	Select the default docking point to which the robot will return.

The detailed method of operation for the specific settings is identical to the delivery mode settings. For details, see “3.2.2.2 Description of Delivery Mode Settings.”.

### 3.2.3.3 More About Food Delivery Mode

Other functions available in the Food Delivery Mode interface include:

Settings	Description
Task History	You can view the previous task executed in the current mode
Steady Mode	When this function is enabled, the robot can travel smoothly at a low speed
Default input method	You can modify the destination search method: Direct location selection/smart location search

The specific, detailed method of operation is identical to the Delivery Mode settings. For details, see “3.2.2.3 More About Delivery Mode”.

### 3.2.4 Cruising Mode

Cruising Mode is for cruising around in a specific environment on a patrol. In the process of cruising, the robot can play certain voice messages and play music.

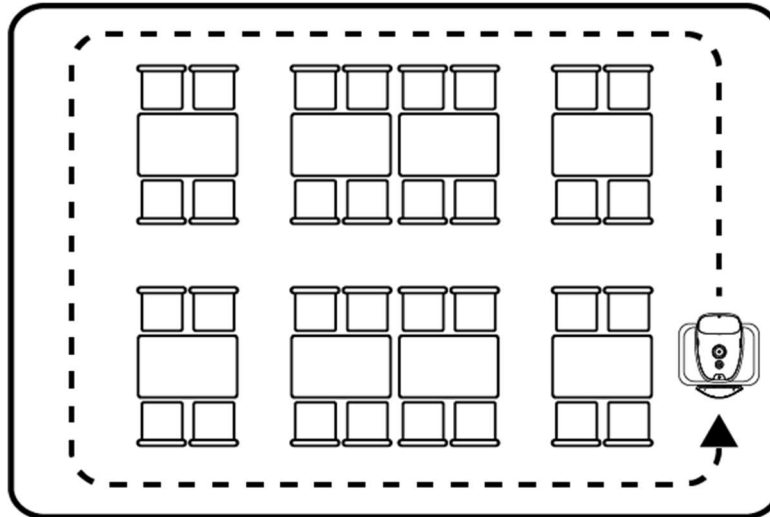

### 3.2.4.1 How to Use the Main Processes for Cruising Mode

Step 1 Select “Cruising” on the home page. After accessing the Cruising Mode interface, the cruising routes will be displayed.

Step 2 Select the cruising route you want to use and tap “Depart.” The robot will begin to patrol along the cruising route.

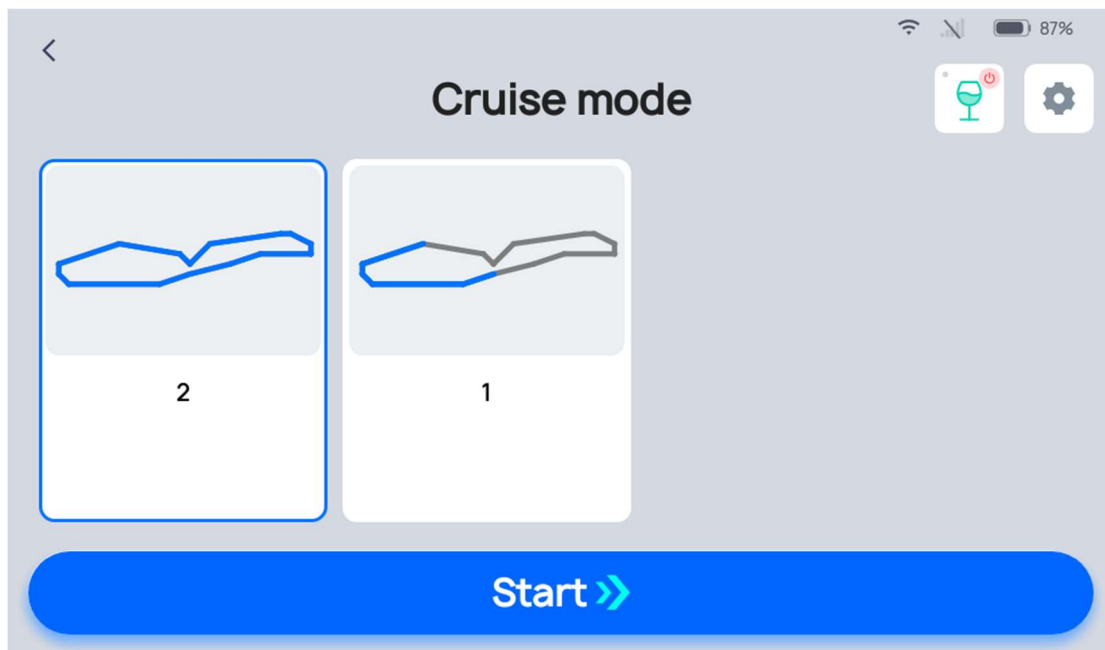

If you want the robot to pause, tap pause on the robot's screen. Once the pause countdown has ended, the robot will continue moving.

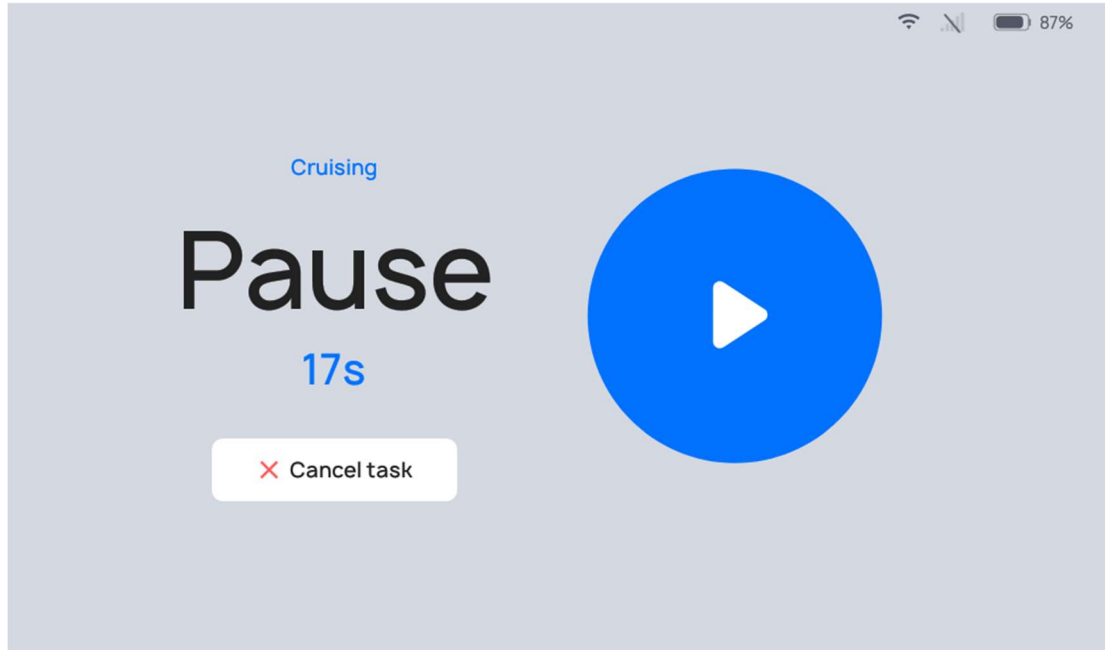

While paused, tap “Cancel Task” to end the cruising task.

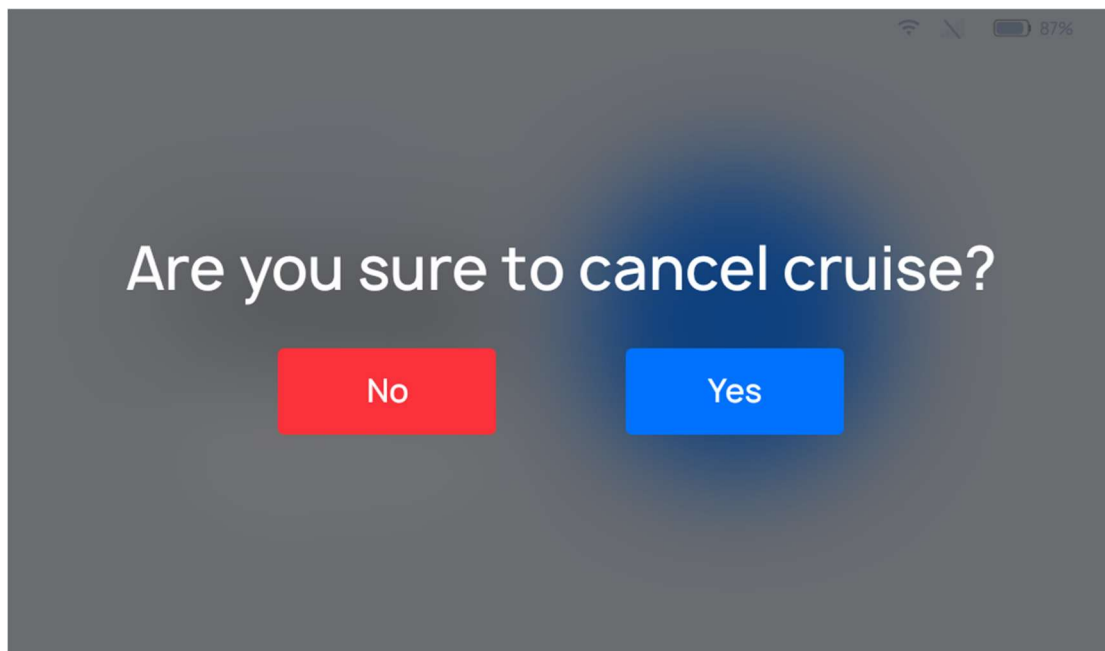

If a rest point is set on the cruising route, the robot will travel to the rest point and stop. You will need to manually tap on the screen for the robot to proceed to the next point on its route.

### 3.2.4.2 Description of Cruising Mode Settings

There is a “⚙️” button at the top of the Cruising Mode interface. Tap it to configure the Cruising Mode settings. The following settings can be configured:

Settings	Description
Cruising Voice Message	When this function is enabled, a voice message will be played while cruising.

Settings	Description
Voice Message for Rests While Cruising	When this function is enabled, a voice message will play upon arrival at rests while cruising.
Cruising Music	When this function is enabled, music will play while cruising.
Stoppage Time at Cruising Points	When this function is enabled, the robot will pause upon arriving at a rest point, and proceed to the next location once the countdown ends.
Cruising Speed	The robot's traveling speed while cruising can be adjusted.

#### Detailed Description:

##### (1) Cruising Voice Messages

Users can customize the content played for cruising voice messages; once customized voice message content is selected to be played, the robot will play the voice message at certain intervals while cruising. Steps for Adding Voice Messages:

Step 1 Go to “Cruising Voice Messages” in the “Settings” interface for Cruising Mode and enable the switch.

Step 2 In the “Cruising Voice Messages” field, enable Cruising Voice Messages and tap on the “+” to open the Edit Voice Message Text window.

Step 3 In the Voice Message Text Editing window, enter the content you want to be played, and tap “Add/Save” to create a customized voice message. Before creating the voice message, you can tap on the “Test Play” button to test the voice message.

Step 4 Select the voice message you created, and it will play when a delivery arrives. If multiple voice messages are selected, the robot will randomly select one voice message to play upon arrival.

#### Note:

- Up to 20 voice messages can be added, and up to 100 Chinese characters per voice message are supported.
- Multiple voice messages can be selected, and one voice message will be randomly selected to play while cruising.
- If you need to delete a customized voice message, long press the corresponding voice message and tap “Delete.”
- The playback interval can be set within the range of 5s-25s; the default is 5s. The playback interval can be manually changed. After making changes, save the settings

##### (2) Voice Messages at Cruising Rests

Users can choose for the robot to play a voice message at rest points while in Cruising Mode. Steps for Adding a Cruising Rest Point:

Step 1 Go to “Play Voice Message at Rest Points” in the “Settings” interface for Cruising Mode and enable the switch.

Step 2 In the “Cruising Voice Messages” field, enable Cruising Voice Messages and tap on the “+” to open the Edit Voice Message Text window.

Step 3 Select the voice message you created, and it will play when the robot arrives at a rest point. If multiple voice messages are selected, the robot will randomly select one voice message to play upon arrival.

Note:

- Up to 20 voice messages can be added, and up to 100 Chinese characters per voice message are supported.
- Multiple voice messages can be selected, and one voice message will be randomly selected to play while cruising.
- If you need to delete a customized voice message, long press the corresponding voice message and tap “Delete”.
- The playback interval can be set within the range of 5s-25s; the default is 5s. The playback interval can be manually changed. After making changes, save the settings.

### (3)Cruising Music

The user can choose for the robot to play music while in Cruising Mode. The robot will travel and play voice messages while cruising. Steps for Adding Cruising Music:

Step 1 In the home page interface, enter “Settings” - “Music Library,” tap “Import Music” in the top right corner of the interface, and import the music by scanning the code with your phone.

Step 2 Go to “Delivery Arrival Music” in the Cruising Mode “Settings” interface and enable the switch.

Step 3 Step 3 By checking the box to select music, you can select the music that the robot plays upon arrival. If multiple music files are selected, the robot will randomly select the music to play while cruising.

Note:

Music added to the Music Library can be automatically synced to the Cruising Mode music and can be played once selected:

- Up to 20 music files can be added to the Music Library, and the added music can be automatically displayed in the “Cruising Music” list.
- Multiple music files can be selected, and music will be randomly selected to play while cruising.
- Music cannot be deleted from the Cruising Music list. If you need to delete a music file, you will need to go to “Settings” - “Music Library” to delete it.

### (4)Cruising Stoppage Time

The robot’s stoppage time at rest points can be set, and the robot will count down at the rest point based on a predetermined period of time. The steps for settings are as follows:

Step 4 Go to “Stoppage Time at Rest Points” in the Cruising Mode “Settings” interface and enable the switch;

Step 5 In the text box, enter the stoppage time at rest points (input range of 1s-600s). Once the robot’s countdown for the rest time ends, it will proceed to the next rest point.

(5) Cruising Speed

The robot can be configured to return to its docking point at a predetermined speed. The default speed is 0.8m/s, and this can be adjusted by dragging the cursor within the range of 0.5m/s to 0.9m/s.

Note:

If you need to enable higher speeds, you can go to “Settings” - “Advanced Settings” and enable the “High-Gear Traveling Speeds” switch.

### 3.2.4.3 More About Cruising Mode

Other functions available in the Cruising Mode interface include:

Content	Description
Steady Mode	When this function is enabled, the robot can travel smoothly at a low speed

The specific, detailed method of operation is identical to the Delivery Mode settings. For details, see “3.2.2.3 More About Delivery Mode.”

### 3.2.5 Direct Mode

In Direct Mode, the robot can execute a one-way transport operation and remain at the delivery point upon delivery, for use by personnel at the delivery point.

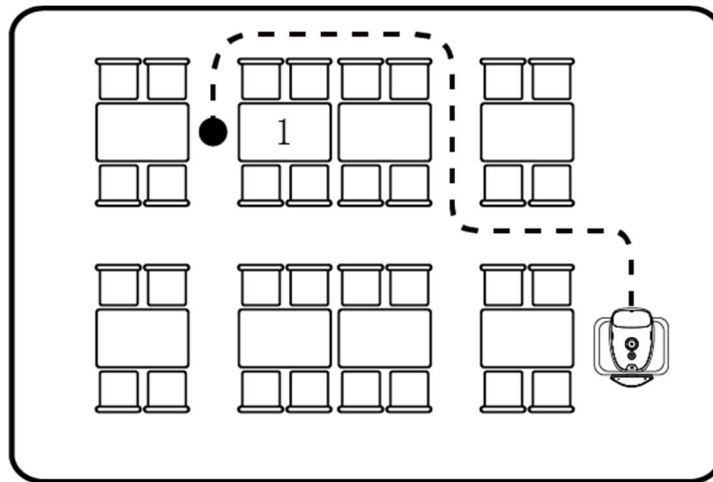

#### 3.2.5.1 How to Use the Main Processes for Direct Mode

The operating steps are as described below.

Step 1 On the robot’s home page, select “Direct”.

Step 2 In the Direct Mode interface, tap the button to select the destination name; after tapping, the destination name will be displayed on the tray.

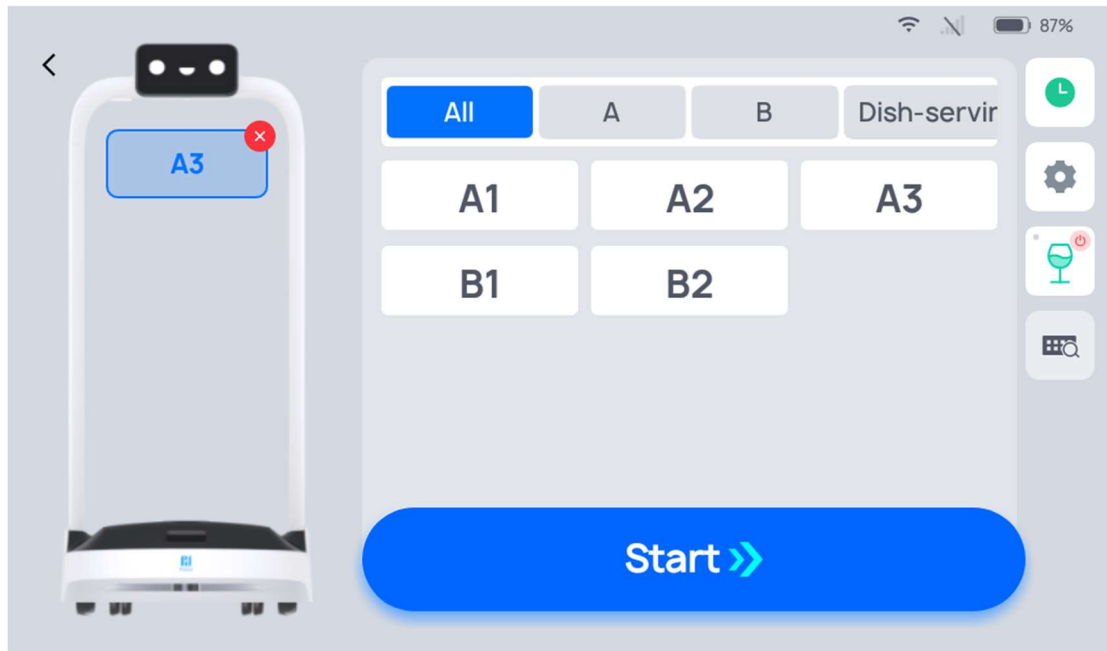

Description

In Direct Mode, only one destination can be selected.

Step 3 Upon reaching the destination, tap “Complete,” that is, the “Complete” button, and the task will be completed.

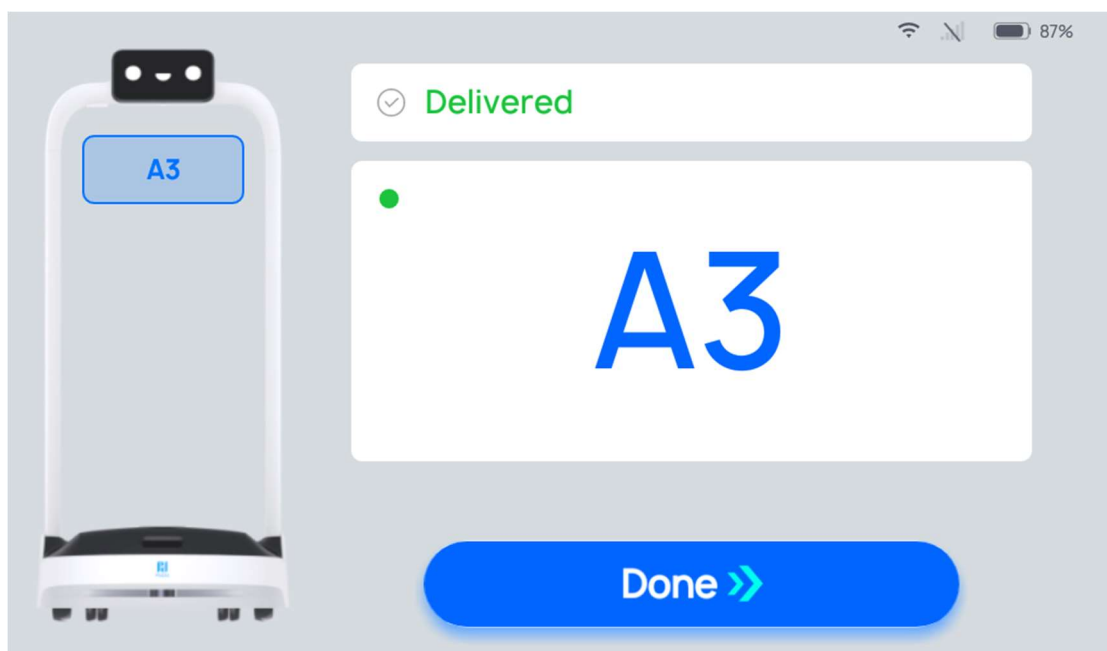

During the process of Direct, if you need to edit a task, force complete, cancel all tasks, or return, you can tap the robot’s screen to pause the robot before proceeding with the operation. If there are no operations during the countdown period, the robot will continue running.



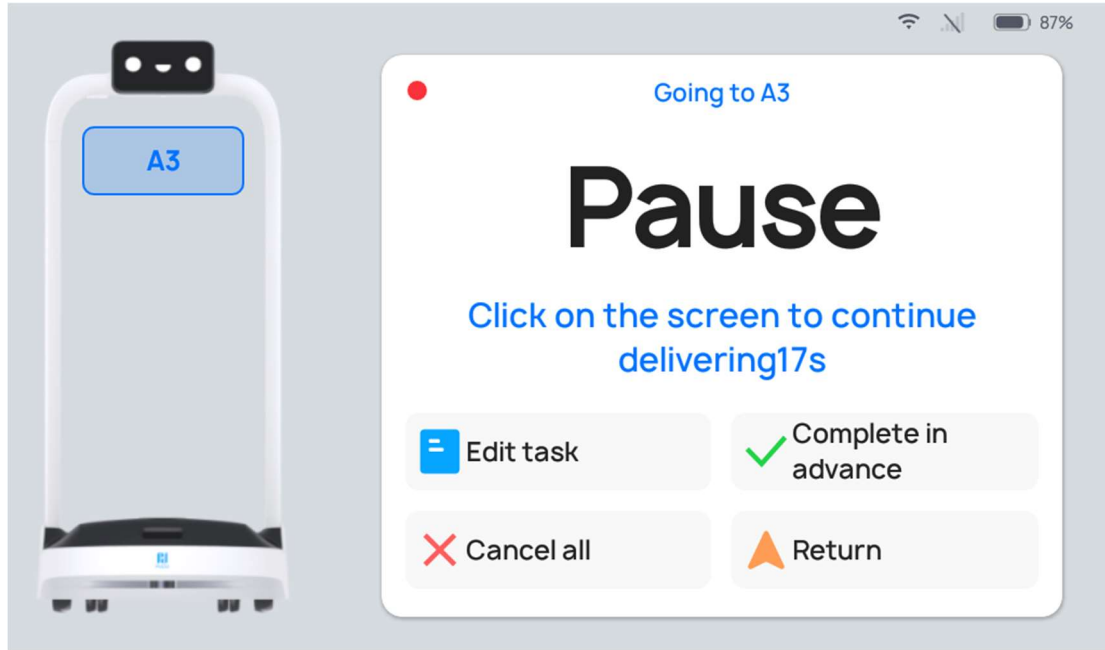

Button	Description
Edit Task	Tap to modify the destination.
Force Complete	Tap this button to force complete the task, and the interface will return to the Direct Mode interface.
Cancel All	Tap to cancel all tasks and not return to the docking point.
Return	Tap to return to the docking point

### 3.2.5.2 Description of Direct Mode Settings

There is a “⚙️” button on the right side of the Direct Mode screen. Tap it to configure the Direct Mode settings. The following settings can be configured:

Settings	Description
Direct Arrival Voice Message	When this function is enabled, a customized voice message will play upon arrival on a Direct task. If multiple voice messages are selected, one will randomly play upon each arrival.
Direct Arrival Music	When this function is enabled, the robot will play music upon arrival on a Direct task.
Music During Direct Tasks	When this function is enabled, music will play while en route for Direct tasks.
Traveling Speed	The robot can be configured to travel at a predetermined speed to a destination.

The detailed method of operation for the specific settings is identical to the Delivery Mode settings. For details, see “3.2.2.2 Description of Delivery Mode Settings”.

### 3.2.5.3 More About Direct Mode

Other functions available in the Direct Mode interface include:

Settings	Description
Task History	You can view the previous task executed in the current mode
Steady Mode	When this function is enabled, the robot can travel smoothly at a low speed
Default input method	You can modify the destination search method: Direct location selection/smart location search

The specific, detailed method of operation is identical to the Delivery Mode settings. For details, see “3.2.2.3 More About Delivery Mode.”.

### 3.2.6 Birthday Mode

Birthday Mode is chiefly used in the settings of sending gifts and playing birthday songs to celebrate a birthday. Tap the menu bar at the docking point and select “Birthday”.

#### 3.2.6.1 How to Use the Main Processes in Birthday Mode

- Step 1 On the home page, select “Birthday” to access the main page for Birthday Mode.
- Step 2 In Birthday Mode, tap the table number button on the right side to select the target table number; after tapping, the selected table number will be displayed on the robot’s tray.

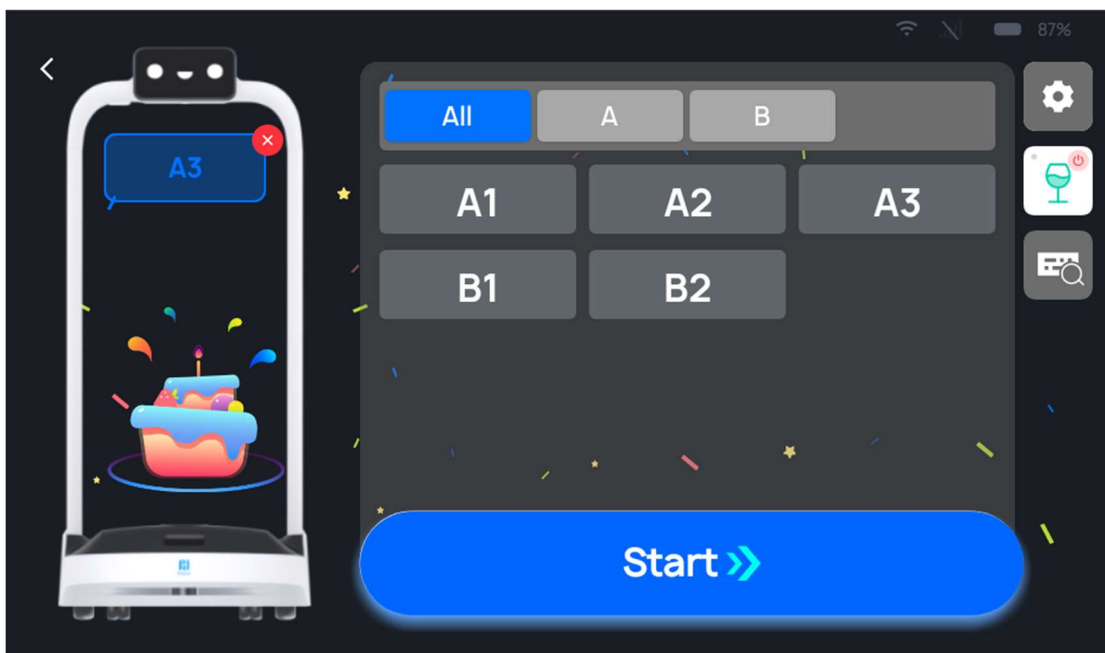

#### Description

Only one table can be selected in Birthday Mode.

---Tap “Depart,” and the robot will follow the set route to reach the destination and play the relevant voice message and music in Birthday Mode.

- Step 3 When the task is finished, tap “Complete,” and the robot will return to the docking point.

During the process of delivering birthday gifts, if it is necessary to edit a task, remove a meal in advance, cancel all tasks, or return, you can tap on the robot's screen to pause the robot before proceeding with the operation. If there are no operations during the countdown period, the robot will continue running.

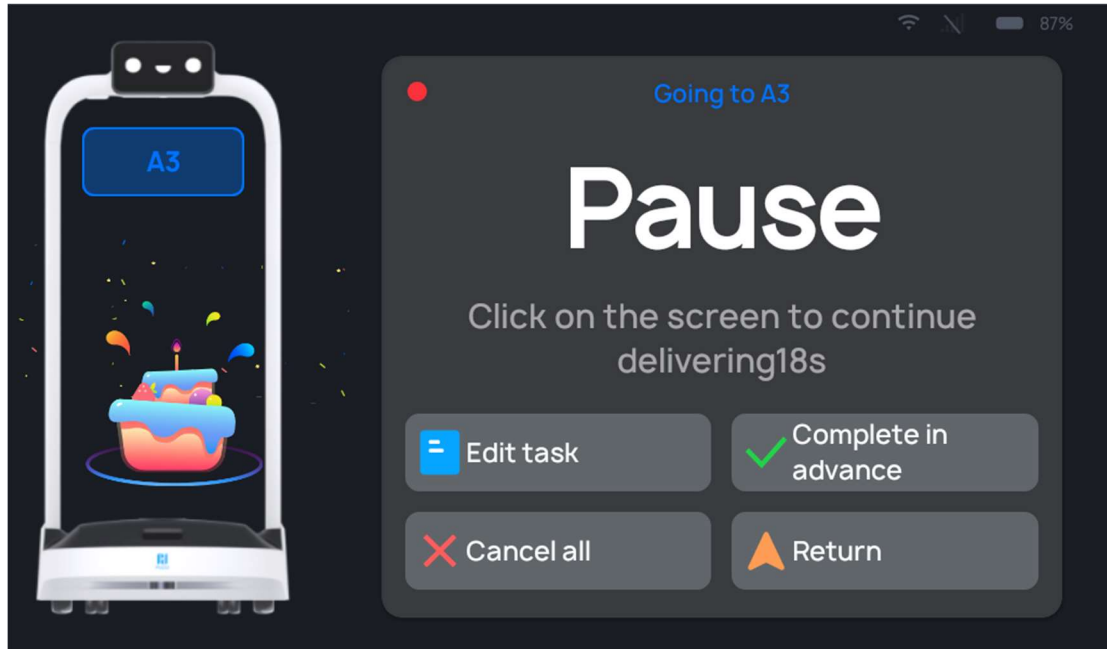

Button	Description
Edit Task	Tap to modify the birthday celebration destination.
Force Complete	Tap this button to force complete the task and return to the docking point.
Cancel All	Tap to cancel all tasks and not return to the docking point.
Return	Tap to return to the docking point.

### 3.2.6.2 Description of Birthday Mode Settings

There is a “⚙️” button on the right side of the Birthday Mode screen. Tap it to configure the Birthday Mode settings. The following settings can be configured:

Settings	Description
Birthday Arrival Voice Message	When this function is enabled, a customized voice message will play upon arrival for a Birthday Mode task. If multiple voice messages are selected, one will play at random upon each arrival.
Birthday Arrival Music	When this function is enabled, the robot will play music upon arrival for a Birthday Mode task.
Play Music During Birthday Tasks	When this function is enabled, music will play while en route for birthday tasks.

Settings	Description
Traveling Speed	The robot can be configured to travel at a predetermined speed to a destination.
Return Speed	The robot can be configured to travel at a predetermined speed when returning to the docking point.

The other settings in Birthday Mode are identical to the Delivery Mode settings. For details, see “3.2.2.2 Description of Delivery Mode Settings.”.

### 3.2.6.3 More About Birthday Mode

Other functions available in the Birthday Mode interface include:

Settings	Description
Task History	The previous task executed in the current mode can be viewed.
Steady Mode	When this function is enabled, the robot can travel smoothly at a low speed.
Default input method	You can modify the destination search method: Direct location selection/smart location search.

The specific method of operation is identical to the Delivery Mode settings. For details, see “3.2.2.3 More About Delivery Mode”.

### 3.2.7 Recycle Modew

Recycle mode is used for the task of recycling items such as plates, parts. The robot can deliver the recycled items from the designated point to the transit location or collection point. .

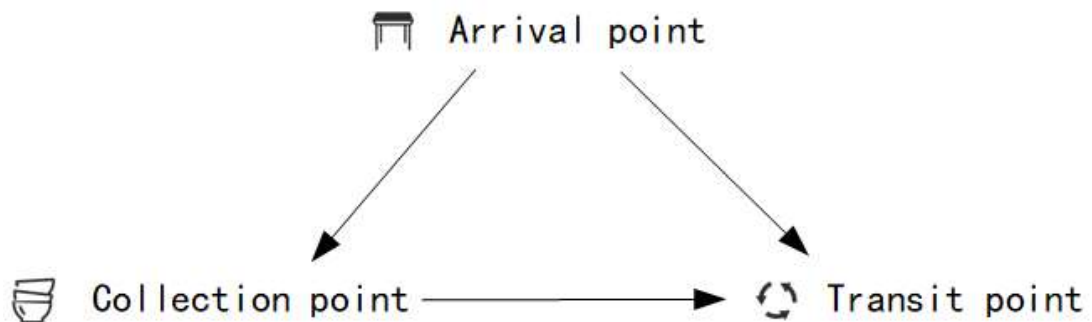

#### 3.2.7.1 How to Use the Main Processes in Recycle Mode

Step 1 On the robot's home page, select “Recycle” to access the main interface for delivery mode.

Step 2 Select the destination on the right side. Once you have finished entering the destination, tap “Go”. The robot will proceed to the corresponding destination.

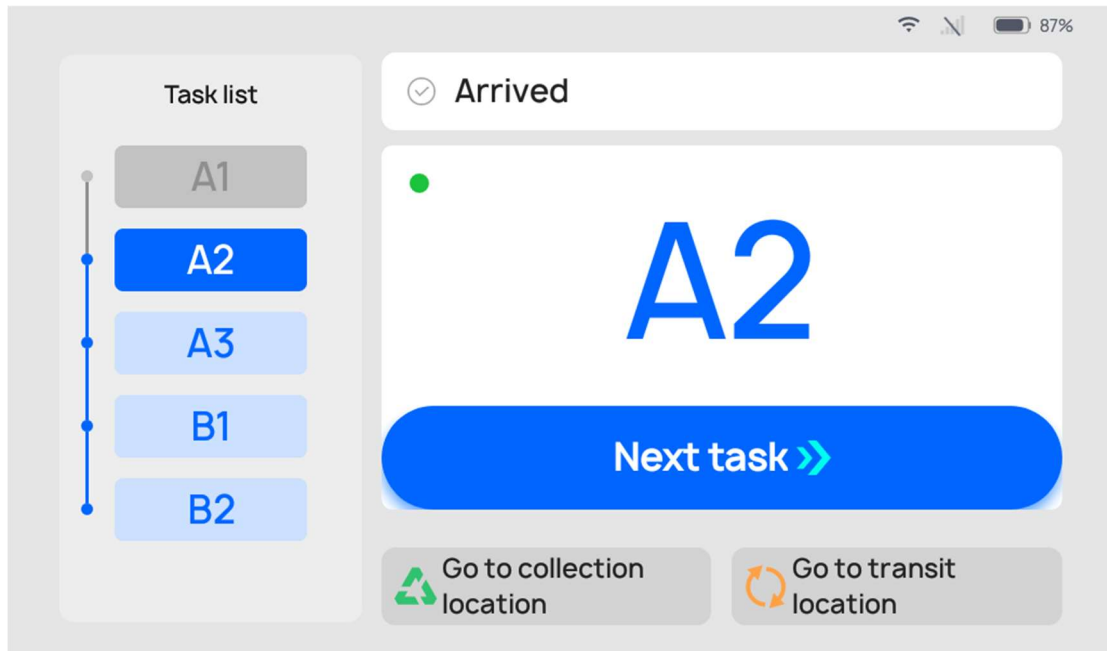

Step 3 When robot reaches its destination, the operator can put items on robot's trays and tap "Next task". And then, the robot will then begin executing its destination.

Step 4 After the robot reaches all the destinations, click "Next Mission" and the robot will execute action according to whether the "transit point" is set in the map:

- When there is a transit point in the map, the robot will go to the transit point. And the robot will stay at transit point.
- When there is no transit point in the map, the robot will go directly to the collection point. And it will go to docking point, after you click "Finish".

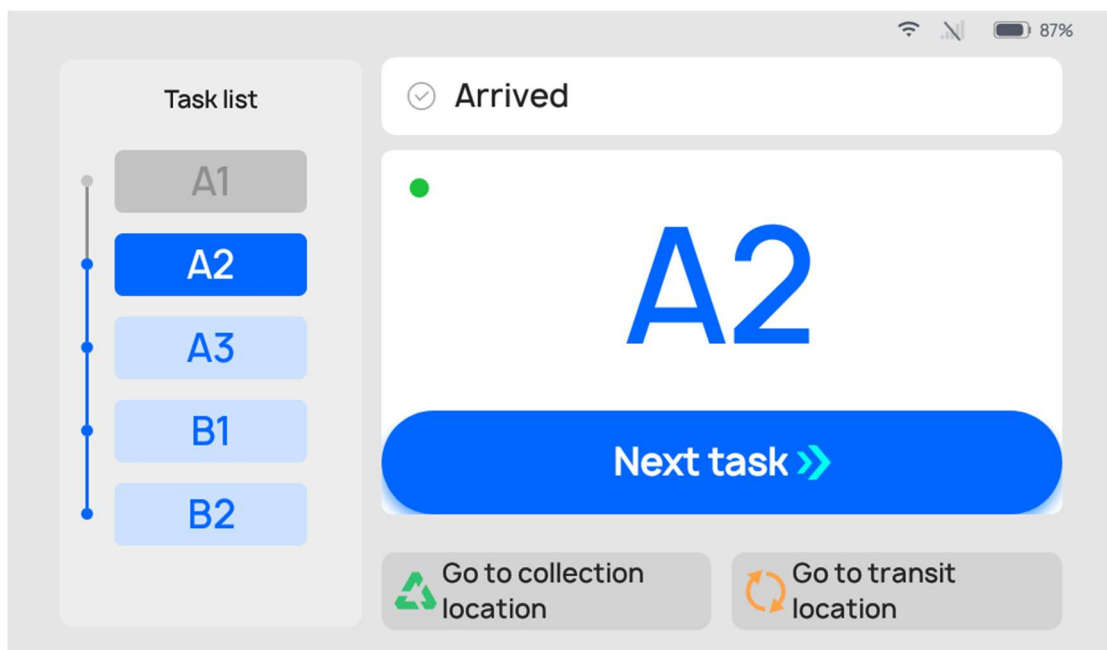

Note:

When there is no transit point in the map, the "Go to the transit point " button in the Recycle

mode will be automatically replaced with "Return ". After clicking, the robot will go directly to the docking point. Other pages are same for it.

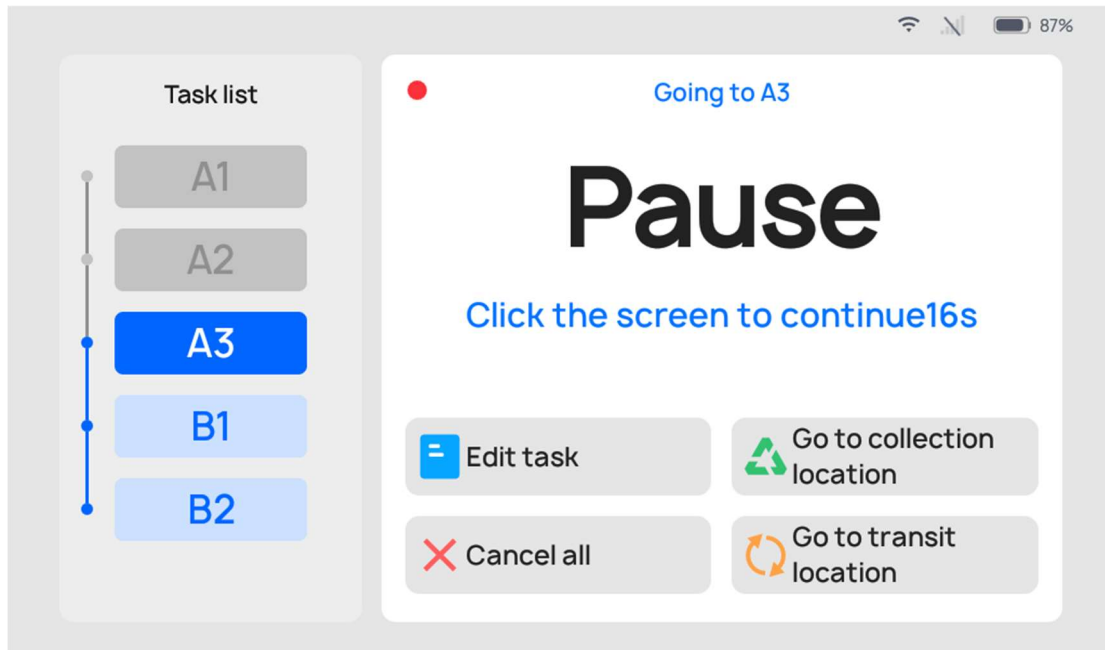

During the recycling process, if it is necessary to edit a task, go to collection point, cancel all tasks, or return, you can tap on the robot's screen to pause the robot before proceeding with the operation. If there are no operations during the countdown period, the robot will continue running.

Button	Description
Edit Task	Tap to modify the destination.
Go to collection point	Tap to force robot to go to collection point
Cancel All	Tap to cancel all delivery tasks and not return to the docking point.
Return	Tap to return to the docking point.

### 3.2.2.2 Description of Delivery Mode Settings

There is a "⚙️" button on the right side of the Delivery Mode interface. Tap it to configure the delivery mode settings. The following settings can be configured:

设置内容	说明
Recycle Arrival Voice Message	When this function is enabled, a customized voice message will play on arrival of a delivery. If multiple voice messages are selected, one will play at random for each arrival.
Recycle Arrival Music	When this function is enabled, the robot will play music when it arrives on a Recycle task.
Play Music During	When this function is enabled, music will be played while en route

设置内容	说明
Recycle	for Recycle.
Traveling Speed	The robot can be configured to travel at a predetermined speed to a destination.
Return Speed	The robot can be configured to travel at a predetermined speed when returning to the docking point.
Select transit location	Select the default Transit location that robot goes to.
Select collection location	Select the default Collecting port that robot goes to.

The detailed method of operation for the specific settings is identical to the delivery mode settings. For details, see “3.2.2.2 Description of Delivery Mode Settings.”

### 3.2.2.3 More About Recycle Mode

Other functions available in the Recycle Mode interface include:

Settings	Description
Task History	The previous task executed in the current mode can be viewed.
Steady Mode	When this function is enabled, the robot can travel smoothly at a low speed.
Default input method	You can modify the destination search method: Direct location selection/smart location search.

The specific method of operation is identical to the Delivery Mode settings. For details, see “3.2.2.3 More About Delivery Mode”.

## 3.3 Settings

Swipe the tab at the left-hand side of the robot’s homepage to access the “Settings” button. Tap to access the general setup screen for the robot. The setup interface allows you to configure the robot's operational settings.

Settings	Description
Basic Settings	Set screen brightness and language.
Network	Can be set as wireless LAN or 4G network. If the robot is not connected to a network, then the robot will not be able to perform version updates and other operations.
Bluetooth	You can set up a Bluetooth connection

Settings	Description
Map	Management module for the robot's operating maps. You can switch between operating maps, select the return point, and configure other settings.
Volume	Adjust song volume, voice message volume, and key press volume.
Music Library	You can import music and manage the music on the device. Up to 20 music files can be imported onto the device.
Speed	Sets the robot's traveling speed in different modes, including the individual's traveling speed, return speed, and cruising speed, and turns off the robot's Steady Mode.
Charging setting	Sets the automatic charging configuration. It needs to be used with the PUDU charging pile.
Version Update	If it is not the latest version, you can download the latest version and update it. Before updating, please ensure that the robot has at least 20% battery remaining, otherwise the update may fail.
About	Displays manufacturer service information, such as the official website information, robot operations guide, etc.
Debugging	Debugs the robot parameters, for technical support engineers only. The Company will not bear any liability for issues arising from unauthorized operations.
Advanced Settings	Enable multiple trays for a single table, set delivery parameters, and other functions. Advanced settings are Advanced Robot Operations; please contact a technical support engineer to get the method of operation. The Company will not bear any liability for issues arising from unauthorized operations.

### 3.3.1 Basic Settings

In Basic Settings, you can adjust the screen brightness and select the device language.



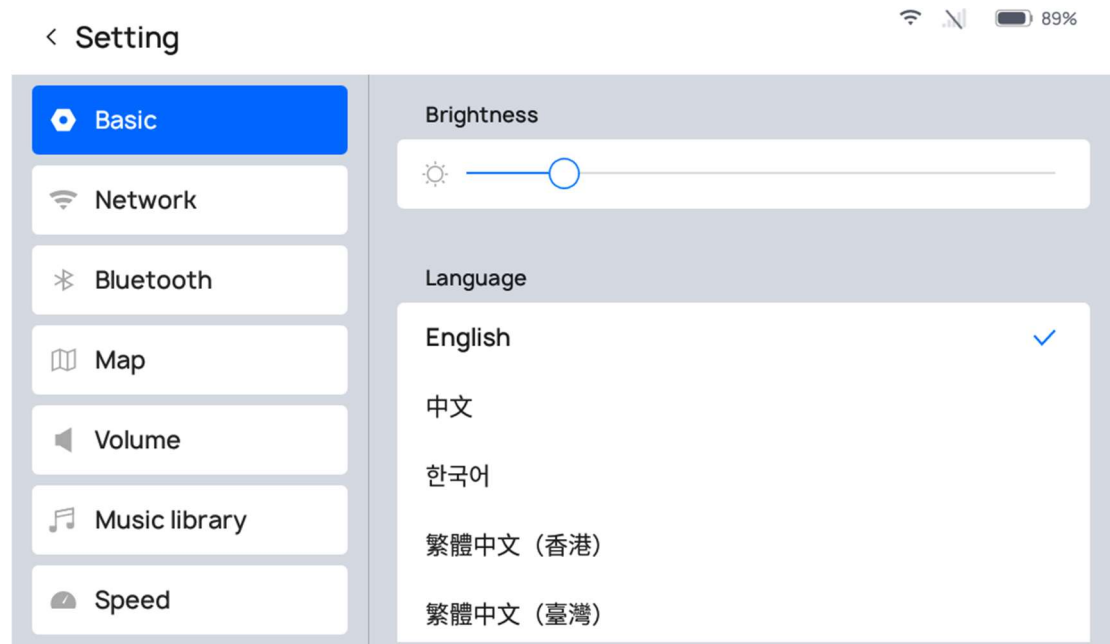

### 3.3.2 Network

In Network Settings, the device can be configured for a 4G network or wireless LAN. A device without a network connection cannot perform version updates.

### 3.3.3 Bluetooth

The device's Bluetooth module can be enabled or turned off.

### 3.3.4 Map

The robot can support the configuration of multiple maps, for use when the usage scenario changes or when the scenario route changes. When you switch maps, the Happy Delivery robot will automatically synchronize the destination information, docking point, and other configured information in the maps. Users can select a map and select a robot docking point based on the actual scenario.

Tap on the map management screen to access the robot Mapping tool software interface and create maps, edit maps, and more.

### 3.3.5 Volume

In Volume Settings, you can adjust the robot's song volume, voice message volume, and key press volume. The specific meaning for each type of volume is as follows:

- Song volume: The volume of the songs and music played by the robot;
- Voice message volume: The volume of the voice messages played by the robot, including default voice messages and customized voice messages;
- Key press volume: The volume of the key press sound when operating the robot.

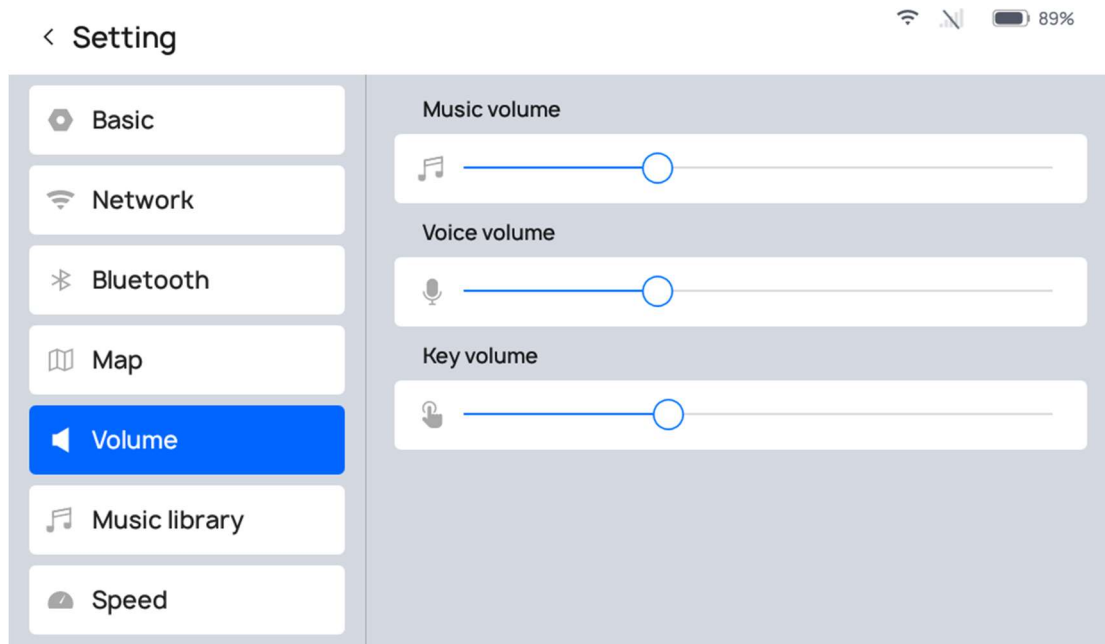

### 3.3.6 Music Library

In the Music Library module, users can import music for the robot by connecting the robot to the same Wi-Fi as their phone and scanning the QR code in the “Import Music” module. Imported music files will be displayed in the “List of All Music.” The robot can store up to 20 music files.

- Supported music file formats: MP3, WAV, FLAC, AAC, PCM, WMA, APE.
- You can test music by tapping the “” button to the right of the music file;
- By long pressing a song, the “Delete” button will pop up. Tap the button to delete music.

### 3.3.7 Speed

The robot's traveling speed, return speed, and cruising speed can be adjusted on the basis of the actual needs for use. The traveling speed, return speed, and cruising speed are defined as follows:

- Traveling speed: The speed at which the robot travels to the destination;
- Return speed: The speed at which the robot returns from any point to the docking point;
- Cruising speed: The speed at which the robot travels when acting as a patroller;

Range of speeds: 0.5m/s, 0.6m/s, 0.7m/s, 0.8m/s, 0.9m/s

In addition, in order to ensure the smooth delivery of items, you can enable the “Steady Mode”

switch in the Speed Settings. Once the switch is enabled, a “” icon will appear on the screen in all modes. Tap this icon to enable Steady Mode. In Steady Mode, the robot runs more smoothly.

### 3.3.8 Charging setting

In this section, you can set automatic charging configuration on your need.

(1)The switch of automatic self-charging

If there is a charging pile set in the robot map, this switch will be turned on by default. When enabled, the low battery threshold of the robot can be set (the setting range is 5%~50%). When the

battery is lower than this threshold, the robot will automatically go to the charging pile for charging.

(2)Customize time slot for automatic recharging

The automatic charging time period of the robot can be customized, and the robot will only perform the recharging task in the set time period. There will be a time period of "00:00~23:59" in the machine by default. You can also click the "+" symbol to add the time period, and you can open/close each time period through the switch.

When multiple time periods are opened at the same time, the robot will perform automatic recharge if the current moment belongs to any of the open periods.

(3)Select charging pile

If multiple charging pile points are set in the map, you can select the charging pile that the robot automatically charging here.

### 3.3.9 Version Updates

When the robot is connected to the network, it can check whether there are version updates. If a new version of the robot software is available, there will be a red dot prompt next to “Version Update” as a reminder to perform the update.

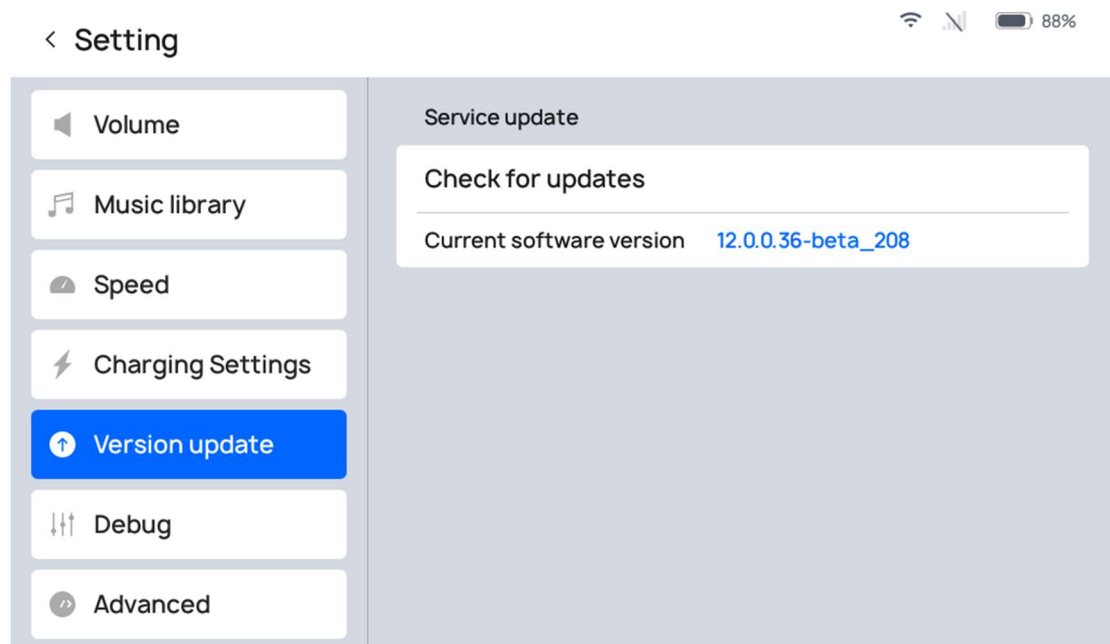

After tapping Update, the robot will download the installation package and a prompt for the download percentage prompt will appear. Once the download is complete for the installation package, the robot will automatically restart.

**⚠ Caution**

When performing version updates, please ensure that the robot has at least 20% battery remaining.

Please do not manually turn off the robot while performing a version update.

### 3.3.10 About

The About interface displays information such as the manufacturer's service hotline, name,

official accounts, etc.

### 3.3.11 Debugging

The Debugging interface is provided for use by technical support to debug the device. Please do not use the Debugging interface yourself.

### 3.3.12 Advanced Settings

The Advanced Settings are used to adjust the robot's advanced configurations, and a password must be entered for access.

Settings	Description
Task Parameter Settings	Set common parameters for each operating mode, including Automatic Return Time and Automatic Resume Time on Pause.
Display emojis during delivery	Controls whether or not the robot displays emojis while executing tasks
High-Gear Traveling Speed	Enables higher traveling speeds
Default input method	The default method for inputting robot destinations in all modes, including direct selection of locations and smart selection of locations

Detailed Description:

#### (1) Task Parameter Settings



There are two items under the Task Parameter Settings:

Enable the right-most switch for “Automatic Return Time after Removing Items” and enter a number in the text box (input range of 1-600, default of “30,” units: seconds) so that, after arriving at a destination, the robot will wait for the period of time input; once the time period ends, it will automatically complete the task.

For “Automatic Resume Time on Pause,” enter a number in the right-hand text box (input range of 5-600, default is “20,” units: seconds) so that the robot will switch to the pause interface if the screen is tapped while the robot is running. The device will then perform a countdown based on the duration set here, and once the countdown ends, it will automatically execute the next task.

#### (2) Display emojis during delivery

**Show emoji during delivery**

---

When enabled, only an emoji, not the table number, will be displayed during the task

When this function is turned on, only emojis are displayed on the delivery map, and the specific destination name is not displayed.

### (3) High-Gear Traveling Speed

**High operating speed**

---

When enabled, you can set a higher speed for the robot

When this function is enabled, adjustable speeds within the range of 1.0m/s~1.2m/s are displayed in the Speed Settings.

### (4) Default input method

The default destination input method can be selected for each mode. There are two input methods:

- **Direct Destination Selection:** The destination list is in a tiled display in the window on the right side of the interface, and you manually and directly find and select the table number.
- **Smart Destination Search:** The robot automatically extracts the first character of all destination names for display, and gradually filters out the destinations by screening the characters as you proceed.

On the “Settings” - “Advanced Settings” page, under “Default Input Method,” you can select the default input method.

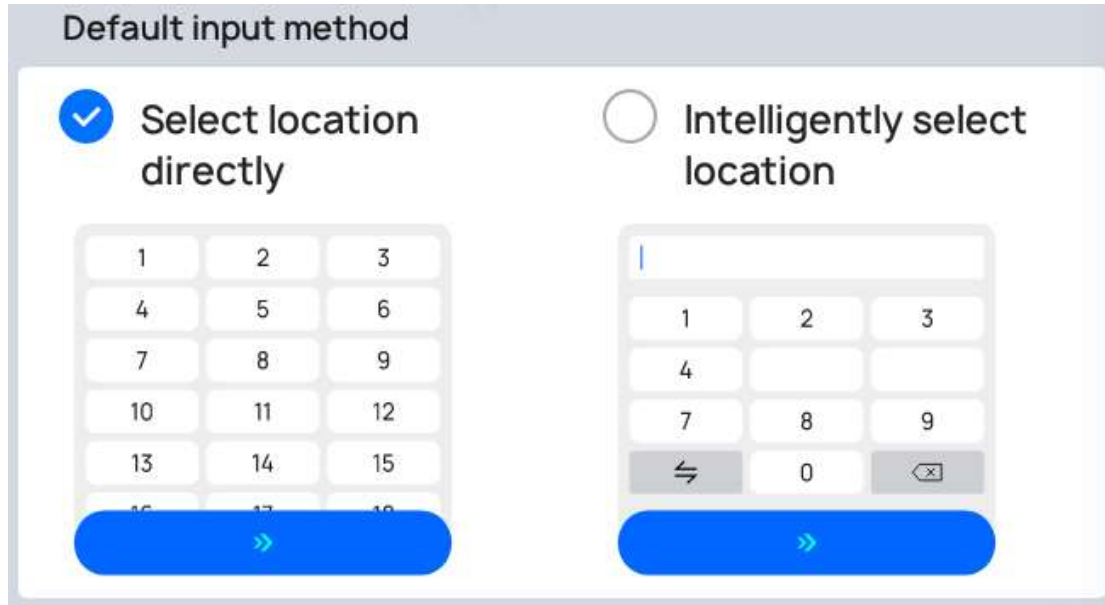

Each time you access the main page for each mode, the destination input method defaults to the input method selected in the Advanced Settings. Of course, you can modify the input method for selecting a delivery destination by tapping on the “” button on the right side of the Delivery Mode home page.

(5) Select tray quantity



The number of trays can be selected according to the actual number of pallets actually assembled by the current robot. The selection range is 1 to 4. After modification, the number of trays in the robot schematic diagram on the left will be changed accordingly on the home page of each mode.

### 3.4 Tray Adjustment

The position of PuduBot 2’s trays can be adjusted according to the actual situation, with a total of 7 optional positions: During tray adjustment, the screen printing numbers (from back to

front) on the tray's fixture should be the same as those on the robot (from top to bottom) so that all trays' outer edges are vertically aligned.

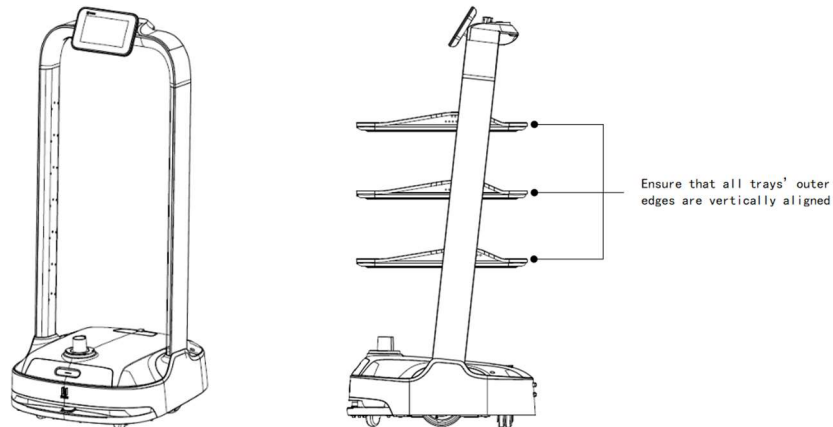

### 3.5 Docking Instructions

PuduBot 2 supports three docking modes. In actual scenarios where multiple robots cooperate, users can select any docking mode during mapping. This section only covers the description of the three docking modes. For details about mapping, please contact our technical engineers.

Three docking modes: ◦

- One-to-one Docking mode: Each robot has its fixed pickup location (docking location).
- Free Docking mode: Set multiple pickup locations (docking locations) for the robot to dock by priority, i.e., the robot chooses the nearest pickup location for docking.
- Waiting mode: Set temporary docking location. When the robot has no task and there's no vacancy at the pickup locations (docking locations), the robot docks at the temporary docking location. Once a vacancy appears at a pickup location (docking location), the robot automatically goes there for docking.

## 4. Troubleshooting

### 4.1 Troubles during Operation

#### Troubles

The following errors may be reported during the robot operation:

- Motor parameters error
- Sensor parameters error
- Sensor connection error
- Motor rotation anomaly

#### Solution

Step 1 Following the prompts on the screen, tap **OK** or **Continue operation** to see if the robot can continue operation.

Step 2 If not, reboot the robot and re-enter the task.

Step 3 If the problem persists after the reboot, please contact our technical engineers.

### 4.2 Positioning Failure

#### Troubles

The robot screen prompts **Please make sure the robot is parking the booting area and facing the right direction before you click the reposition button.**

#### Possible Causes

- The robot fails to recognize the positioning feature.
- The map selected on the robot does not match the actual site.

#### Solution

Step 1 If the current map of the robot does not match the actual site, tap **Map selection** to select the correct map of the current site.

Step 2 Check if the robot is directly below the boot point. If the robot deviates too far from the boot point, move the robot right below the boot point. If the problem persists, please adjust the orientation of the robot..

Step 3 Check if the vision sensor is blocked by obstacles such as oil stains. If so, clean it with a lens cleaning kit.

Step 4 Check if the fill light of the vision sensor is red. If not, please contact technical engineers in time.

### 4.3 Charging Failure

#### Troubles

Charging failure

#### Solution

- Check if the power switch is turned to “**—**”.



- Check if the charger indicator is on. If not, the charging failure may be caused by a damaged charger. Please contact our technical engineers in time.

#### **4.4 Power-on Failure**

##### **Troubles**

Power-on failure

##### **Solution**

- If the battery is low, please charge the robot in time.
- If the battery level is normal, please check if the power switch is turned to “**—**”.
- If the problem persists, please contact our technical engineers.

#### **4.5 Robot Does Not Move Smoothly**

##### **Troubles**

The robot does not move smoothly or stops moving.

##### **Solution**

- Check if there are obstacles in front of the robot.
- Check if there are stains like oil or soup on the depth vision sensors.
- Check if the passageway is wider than the minimum travel width.
- Check if there are mirrored and reflective metal surfaces on either side of the passageway that may affect the robot's operation. If so, attach matte stickers 5cm~6cm above the ground.

## 5. Maintenance and Care

### 5.1 Component Maintenance

Components	Robot Status	Inspection Interval	Method
Trays, drive wheels, and auxiliary wheels	Powered off	Weekly	Wipe the surface with a clean cloth.
Vision sensor, depth vision sensors, and Lidar	Powered off	Weekly	Use a clean cloth or lens cleanser for the cleaning.
Robot	Powered off	Monthly	Wipe the surface with a clean cloth.

### 5.2 Cleaning Method



Warning

Do not use water or any other liquid to clean the robot. Always make sure that the robot is kept dry.

- Step 1 Press and hold the power switch for 3 seconds to ensure that the robot is powered off.
- Step 2 Turn the power switch to “○”, and make sure that the robot is powered off.
- Step 3 Wipe the robot surface with a clean cloth.
- Step 4 Wipe the trays, drive wheels, and auxiliary wheels with a clean cloth.

 Note

- If the drive wheels or auxiliary wheels are entangled or stuck with debris, please place the robot down on its side for cleaning. Keep the ground clean and tidy (a mat can be used) to avoid scratches on the robot surface when placing the robot down on its side.
- If there are oil stains on the tray pad, take it out and wash it separately. Put back the tray pad after it dries off completely.

Step 5 Clean the vision sensor, depth vision sensors, and Lidar with a clean cloth or specialized lens cleanser.

 Note

- In case of unexpected contamination, address it immediately to avoid blocking the sensor and preventing the robot from working improperly.

## 6. Compliance Information

### 6.1 Federal Communications Commission Compliance Statement

The following information applies to Pudu robotic.

This equipment has been tested and found to comply with the limits for a Class B digital device, pursuant to part 15 of the FCC Rules. These limits are designed to provide reasonable protection against harmful interference in a residential installation. This equipment generates, uses and can radiate radio frequency energy and, if not installed and used in accordance with the instructions, may cause harmful interference to radio communications. However, there is no guarantee that interference will not occur in a particular installation. If this equipment does cause harmful interference to radio or television reception, which can be determined by turning the equipment off and on, the user is encouraged to try to correct the interference by one or more of the following measures:

- Reorient or relocate the receiving antenna.
- Increase the separation between the equipment and receiver.
- Connect the equipment into an outlet on a circuit different from that to which the receiver is connected.
- Consult the dealer or an experienced radio/TV technician for help.

This device complies with Part 15 of the FCC rules. Operation is subject to the following two conditions:

- This device may not cause harmful interference.

This device must accept any interference received, including interference that may cause undesired operation.

### 6.2 Industry Canada Compliance Statement

This device complies with Industry Canada licence-exempt RSS standard(s). Operation is subject to the following two conditions:

- This device may not cause interference.
- This device must accept any interference, including interference that may cause undesired operation of the device.

### 6.3 Disposal and Recycling Information



The Waste Electrical and Electronic Equipment (WEEE) Directive aims to minimize the impact of electrical and electronic goods on the environment, by increasing re-use and recycling and by reducing the amount of WEEE going to landfill. The symbol on this product or its packaging signifies that this product must be disposed separately from ordinary household wastes at its end of life. Be aware that this is your responsibility to dispose of electronic equipment at recycling

centers in order to conserve natural resources. Each country should have its collection centers for electrical and electronic equipment recycling. For information about your recycling drop off area, please contact your related electrical and electronic equipment waste management authority, your local city office, or your house hold waste disposal service.



Before placing electrical and electronic equipment (EEE) in the waste collection stream or in waste collection facilities, the end user of equipment containing batteries and/or accumulators must remove those batteries and accumulators for separate collection.